

# Who is the 3rd Angel

Parminder Biant #25,26 Germany international 2019

1989

9/11

2014

2019

2021

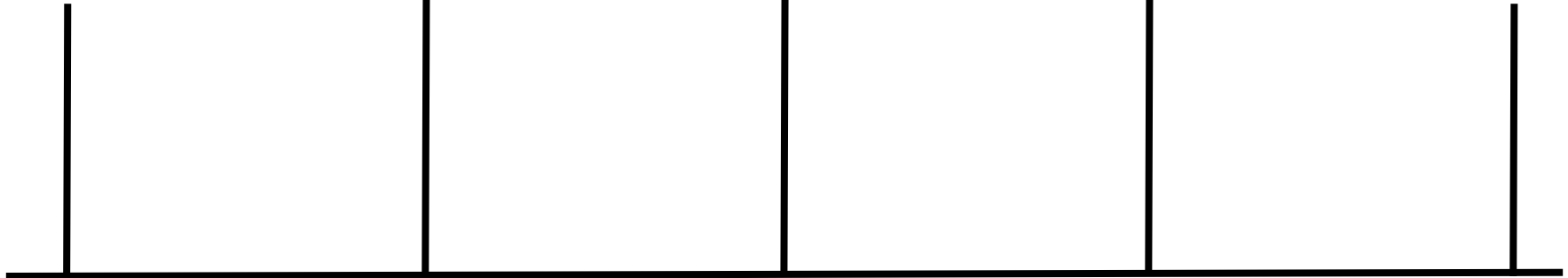

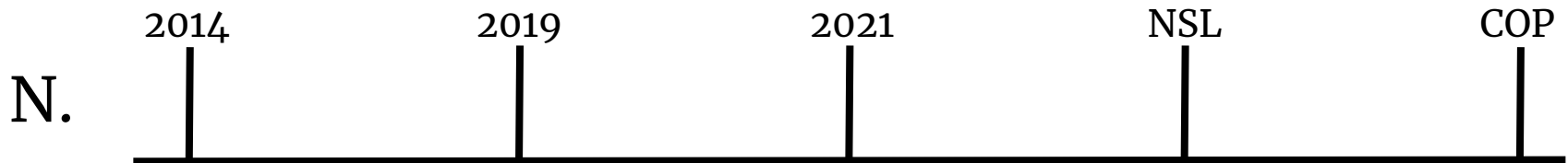
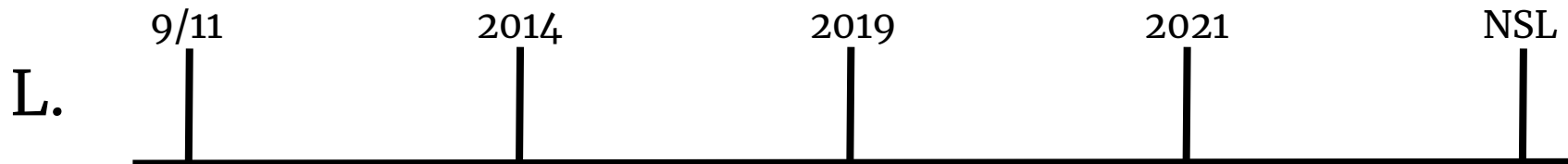
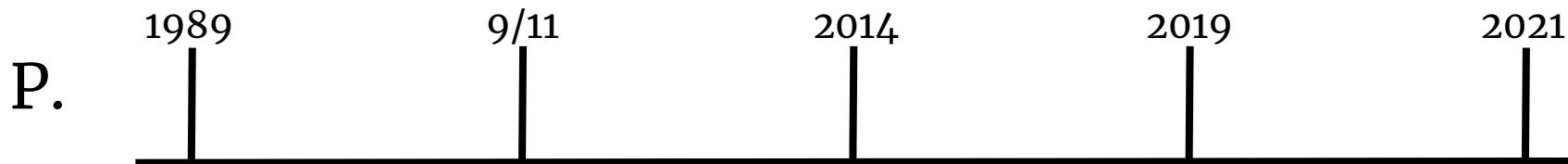
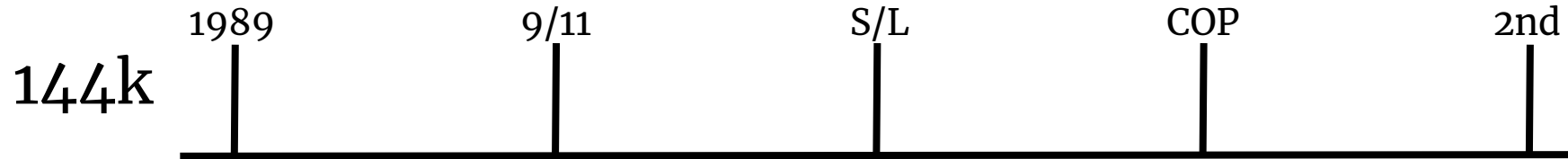

1989

9/11

S/L

1A

2A

3A

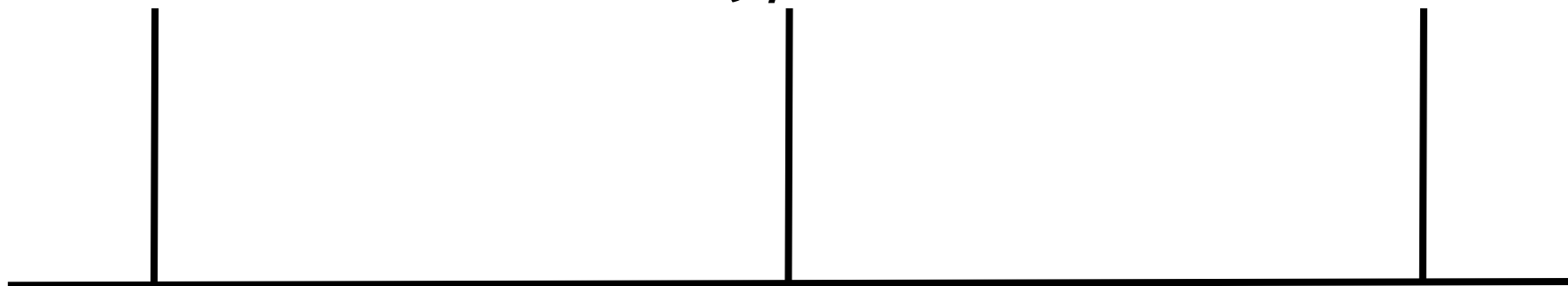

1798

1989

9/11

S/L

1A

2A

3 Arrival

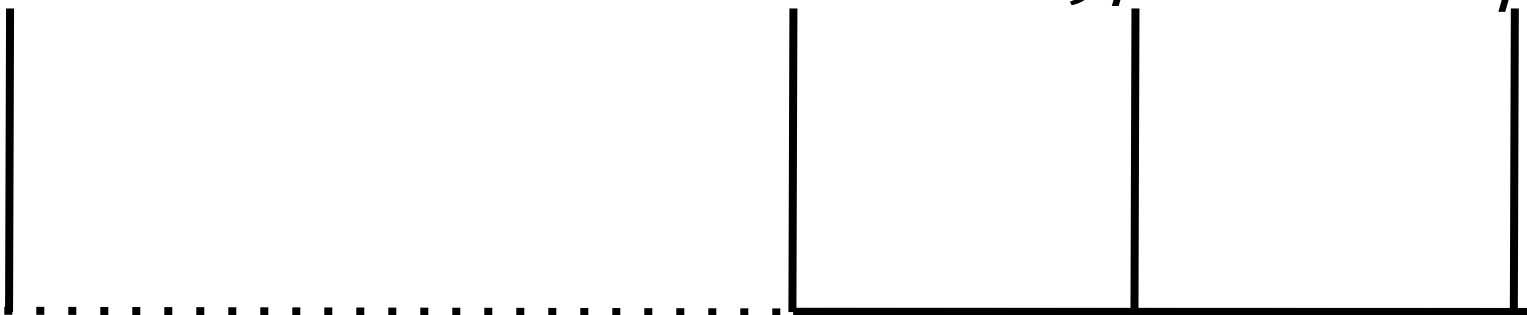

1798



1AM → ?

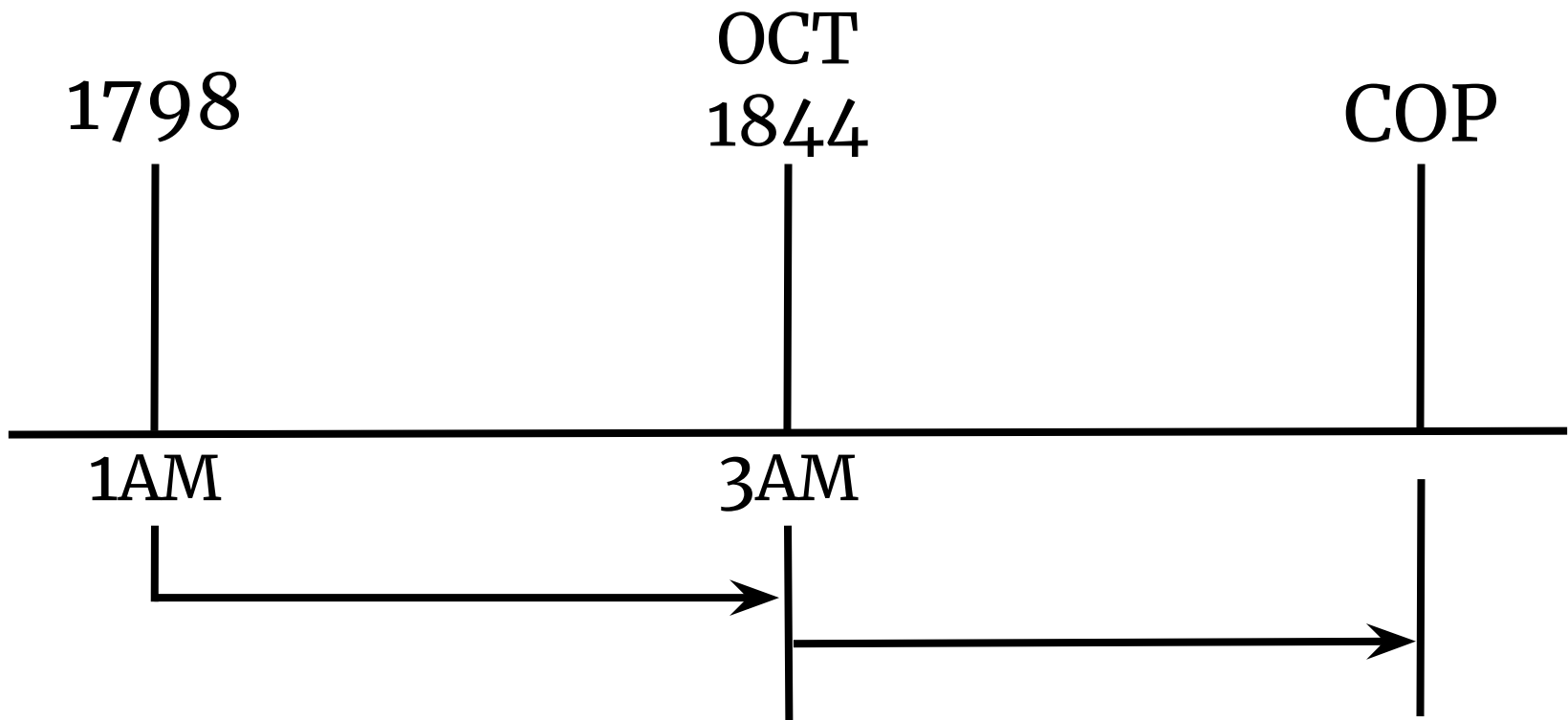

1798

1844

1989

9/11

SL

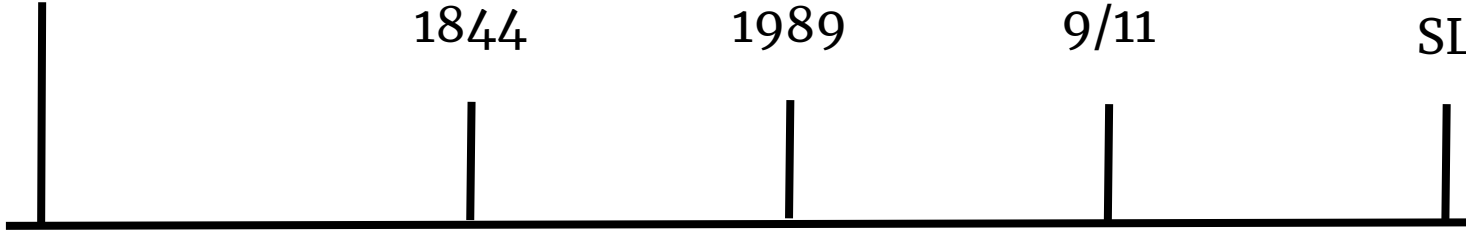

1A

2A

3A



3 Empowered



1798



1A

2A

1844



3A

1989



9/11



SL



3 Arrival



1798

1844

1989

9/11

SL

1A

2A

3A

3 Arrival

3 Empowerment

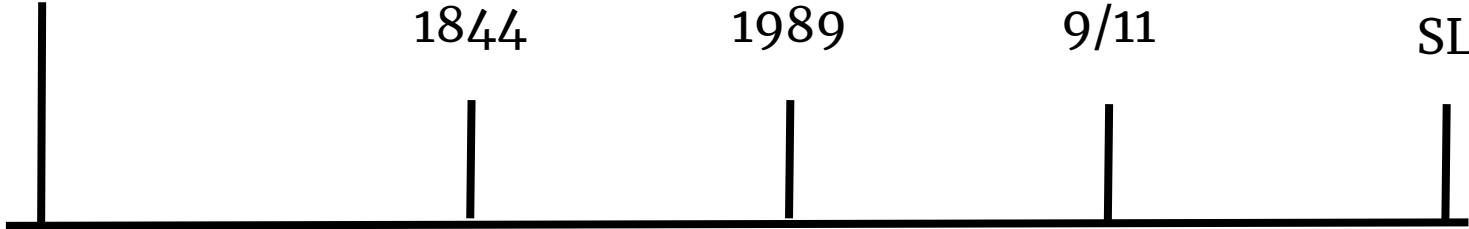

1798



1844



1989



9/11



SL



3 Arrival (144K)

1A

2A

3A



3 Empower

(EGW)

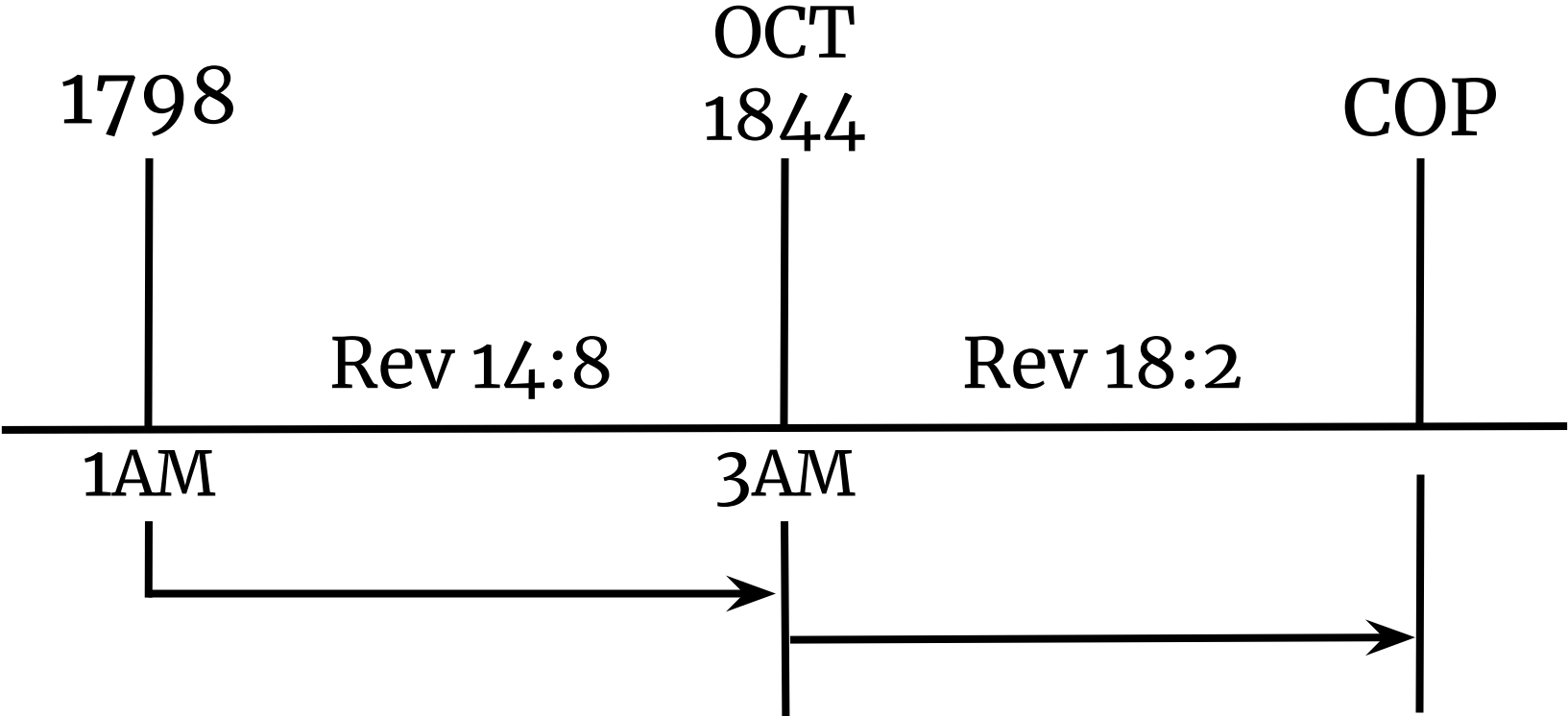

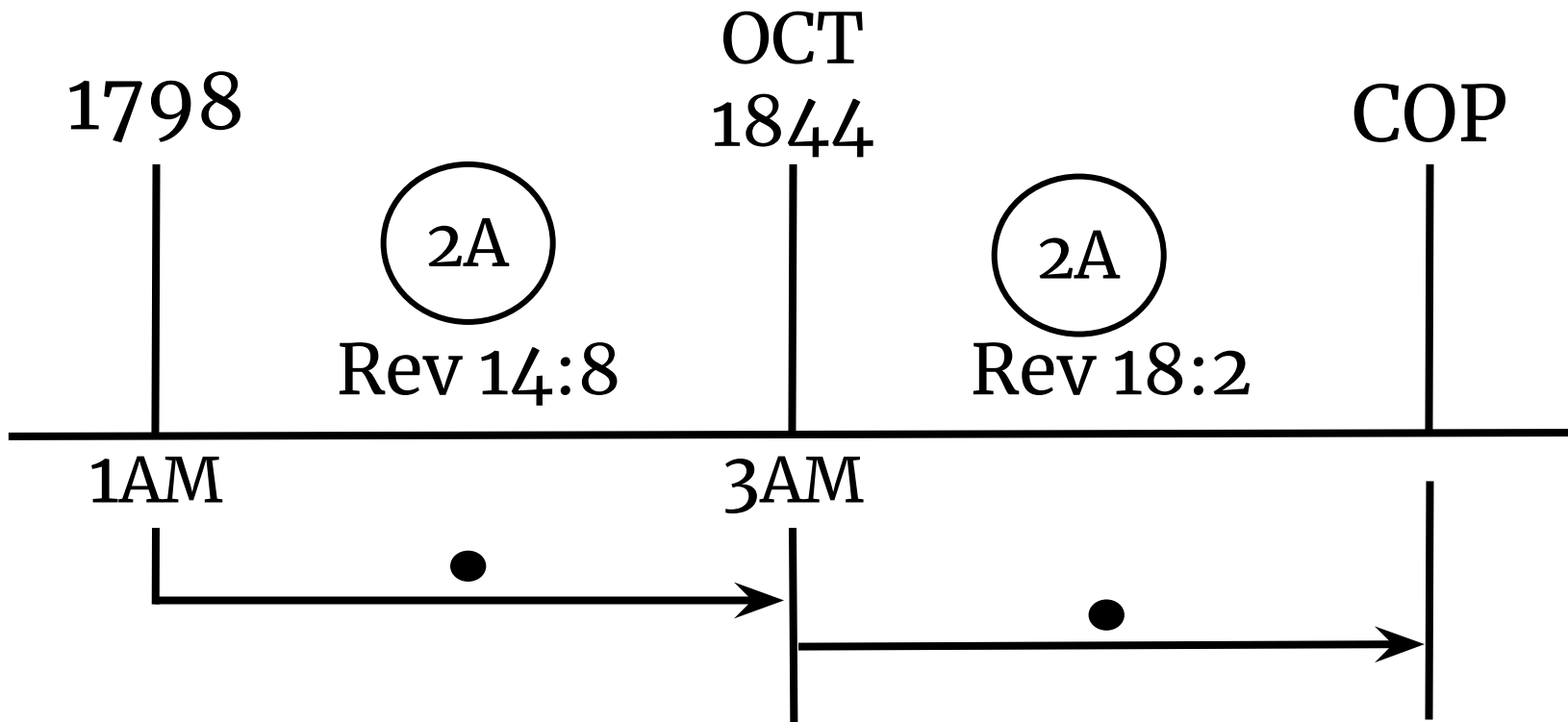

1798



1AM

1844



3AM

1 AM = 3 AM

1798

1844

COP

1AM

3AM

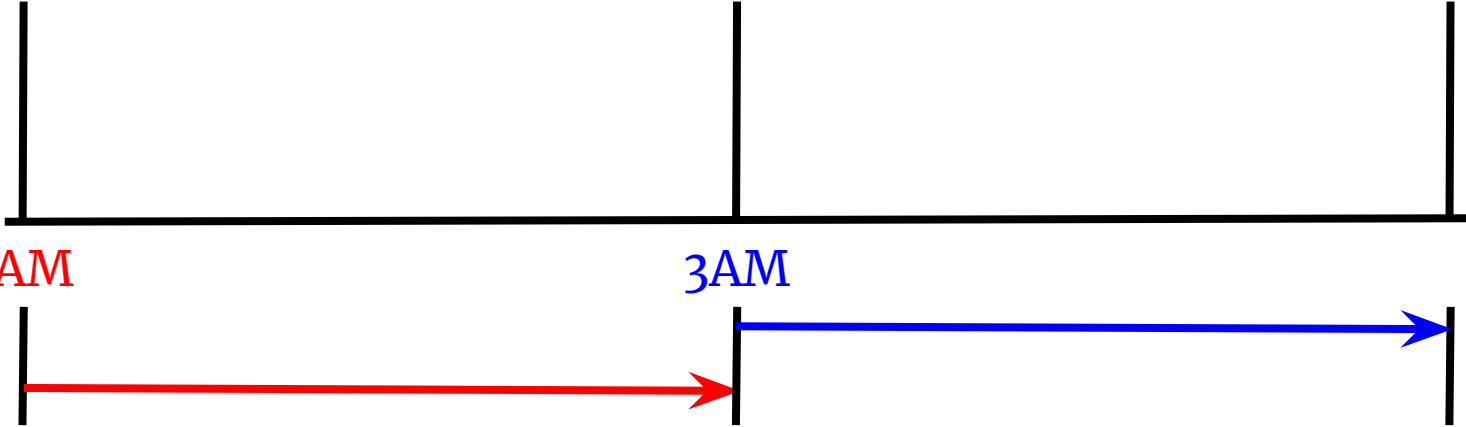



1798



1A

2A

1844



3A

1989



9/11



SL



3 Empowered

2AM+3AM

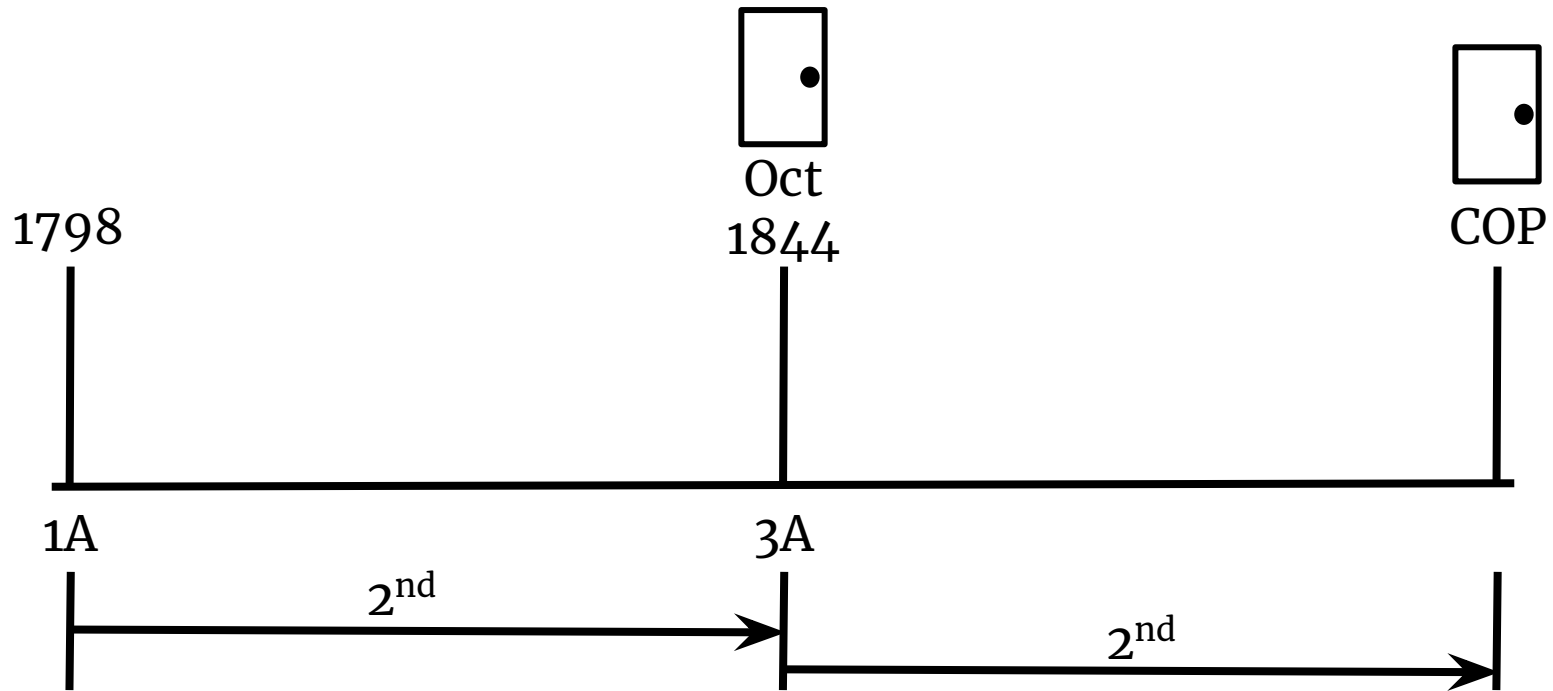

# Structure vs. Thus Saith the Lord

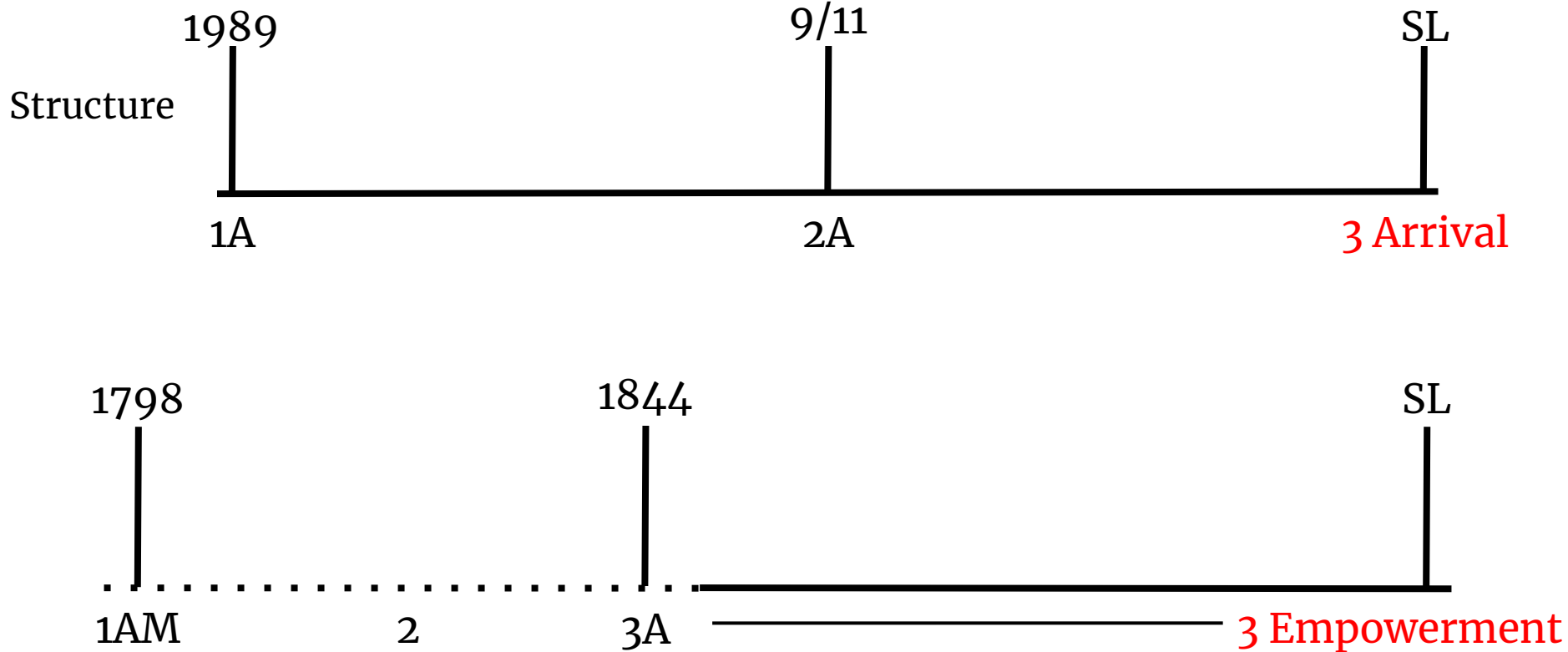

Miller  
1798



1AM

White  
1844



3AM

$$\textcircled{S} = \textcircled{LC}$$

$$\textcircled{M} = \textcircled{EGW}$$

$$1AM = 3AM$$

1<sup>ST</sup> = 3AM



2AM

1798

1844

COP

1AM

3AM

2AM

2AM

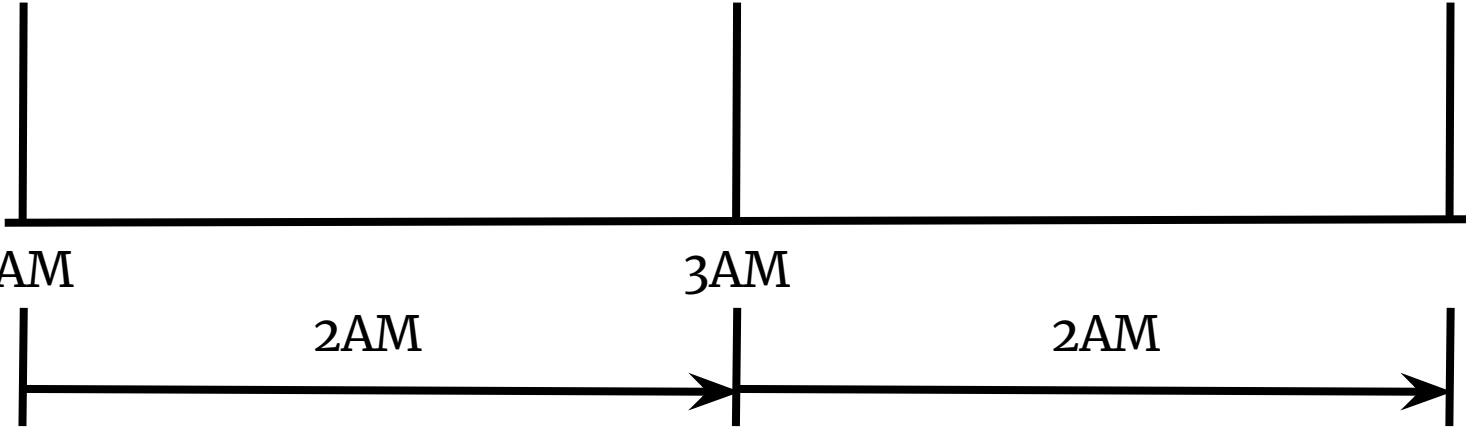



**PANIUM**



Who has the authority?

Deuteronomy 18:18

Jews=

John the Baptist=

144K=

EGW=

Priest vs. Prophet

Priest- Aaron, Conference structure, Male centric

Priest- Melchizedek: Self righteousness

2012

SL  
2014

Agitate

⋮



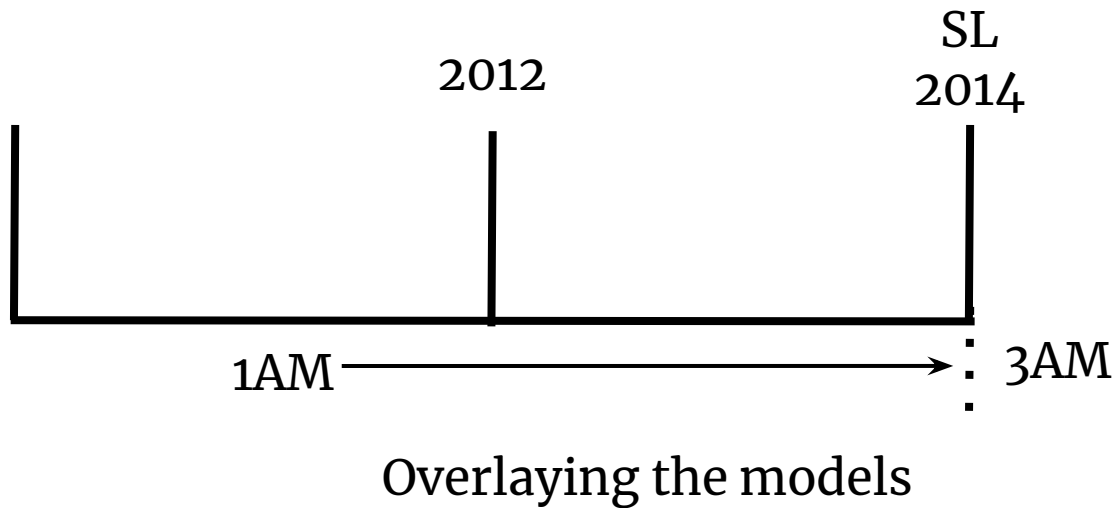

# Thus Saith the Lord + Priest

2012

SL  
2014



3 Arrival (144K- structure)  
3 Empowerment (S.O.P)  
Who (3A)

Who

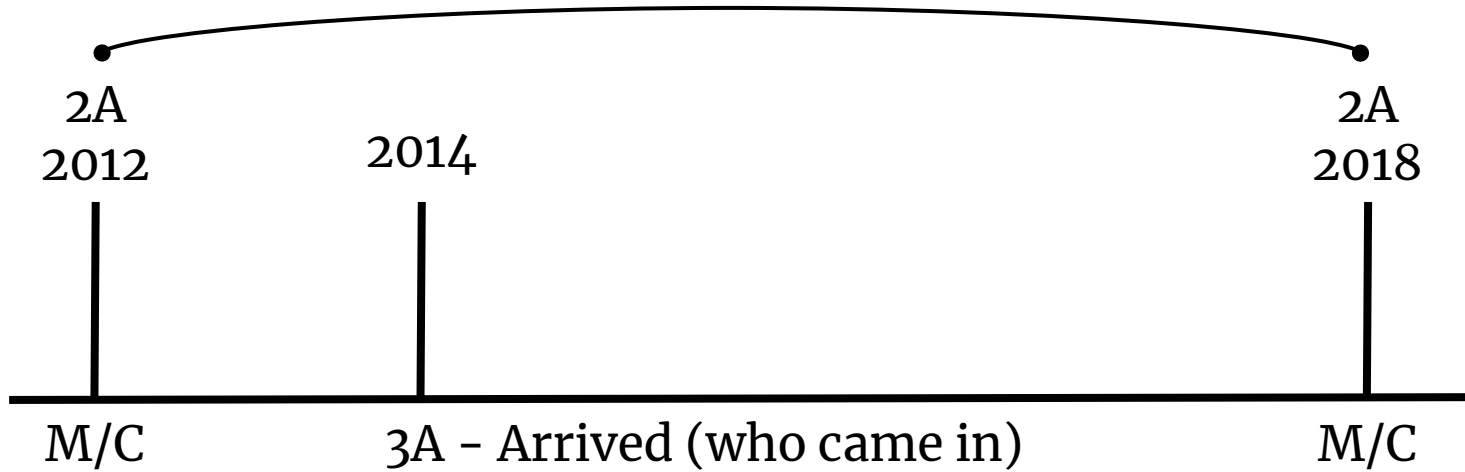

1A - Symbol of person  
2A - Symbol of person  
3A - Symbol of person

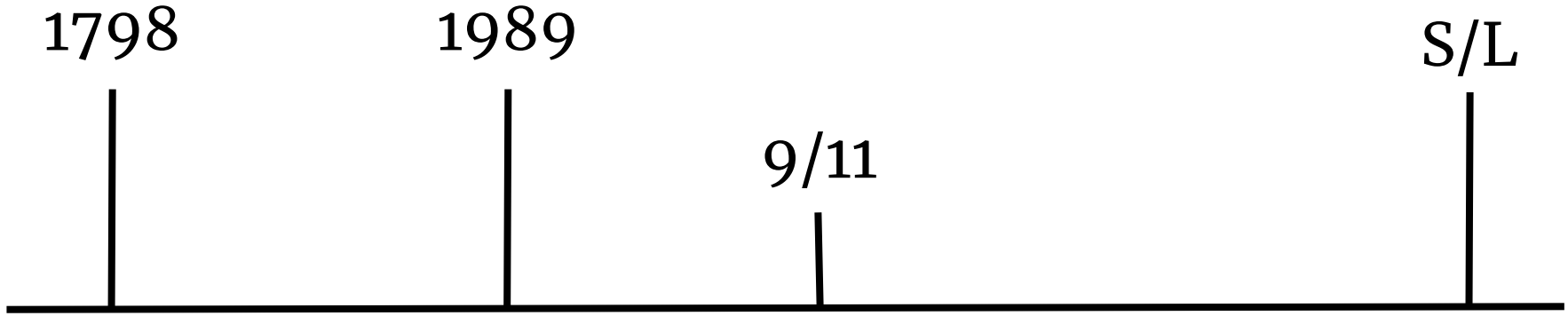

3 Arrival



3 Empowerment

1798

1989

S/L

1844

1A

2A

3A

Isaiah 46:10

$\alpha$

$\Omega$



2 **X**

$\alpha$



$\Omega$



Years



Isaiah 46:10

$\alpha$

$\Omega$

$\alpha$



2 ✓

$\alpha$



$\Omega$  ✓

# Story

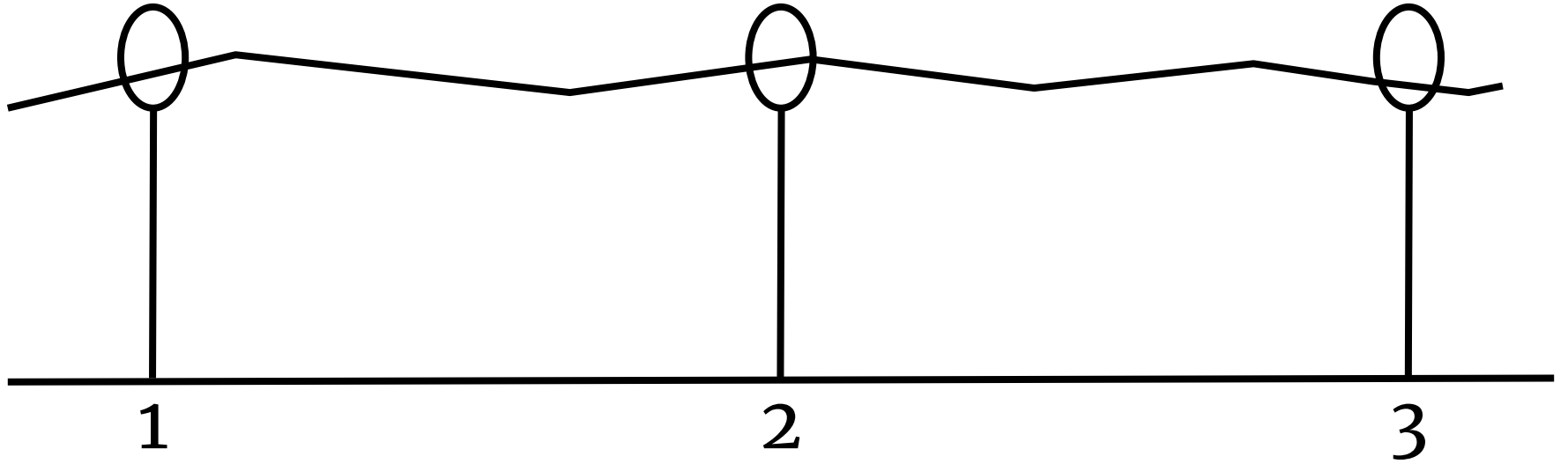

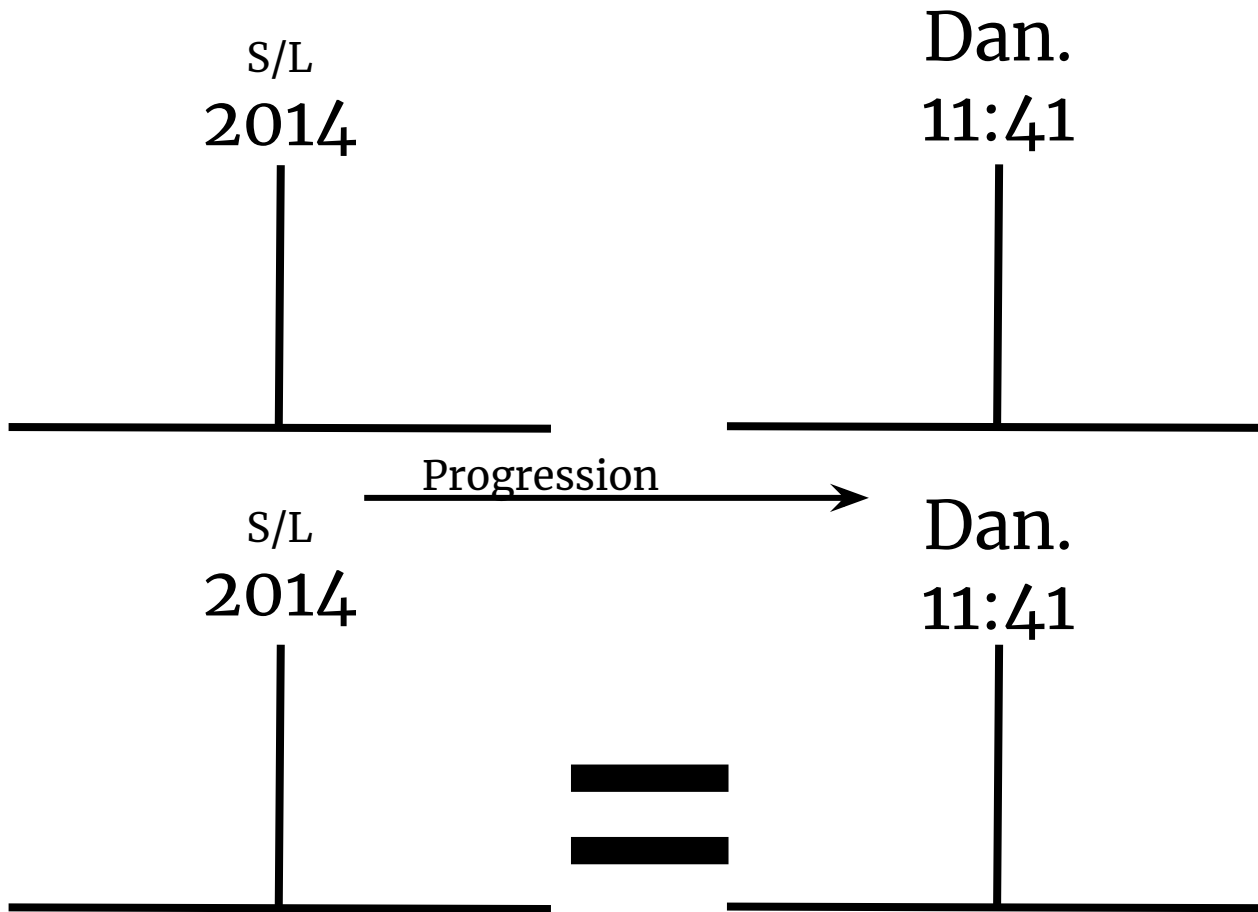

$$\textcircled{S} = \textcircled{LC}$$

$$\textcircled{M} = \textcircled{EGW}$$

$$\textcircled{1} \quad \textcircled{2-3} \quad \textcircled{4}$$

