

# *Camp Meeting Guadeloupe*

The Diadochi Wars 3 of 15

Tess Lambert

April 2019

We've been studying Acts 27 in two parts, two ships, and then we've taken those two parts, perhaps without realizing it, we've studied this chapter as if it was a parable, because it is a parable. We've compared these two lines on two journeys, or two ships, and we saw that they represented the same thing: institutions or structures of the United States and Adventism. One gives us an ugly picture of a bad ship that's in a bad condition, it's dead. It has the opportunity to come alive in 1989, and it chooses to abide in its current condition. It takes us from that time through to the midnight cry or Panium. And then we see that it's overturned progressively, leading up to its close of probation which we would normally refer to as the Sunday Law. We know that at the Sunday Law, we mark that "apostasy". But it's the end of the sixth head, the end of the institutions of the United States as we know them.

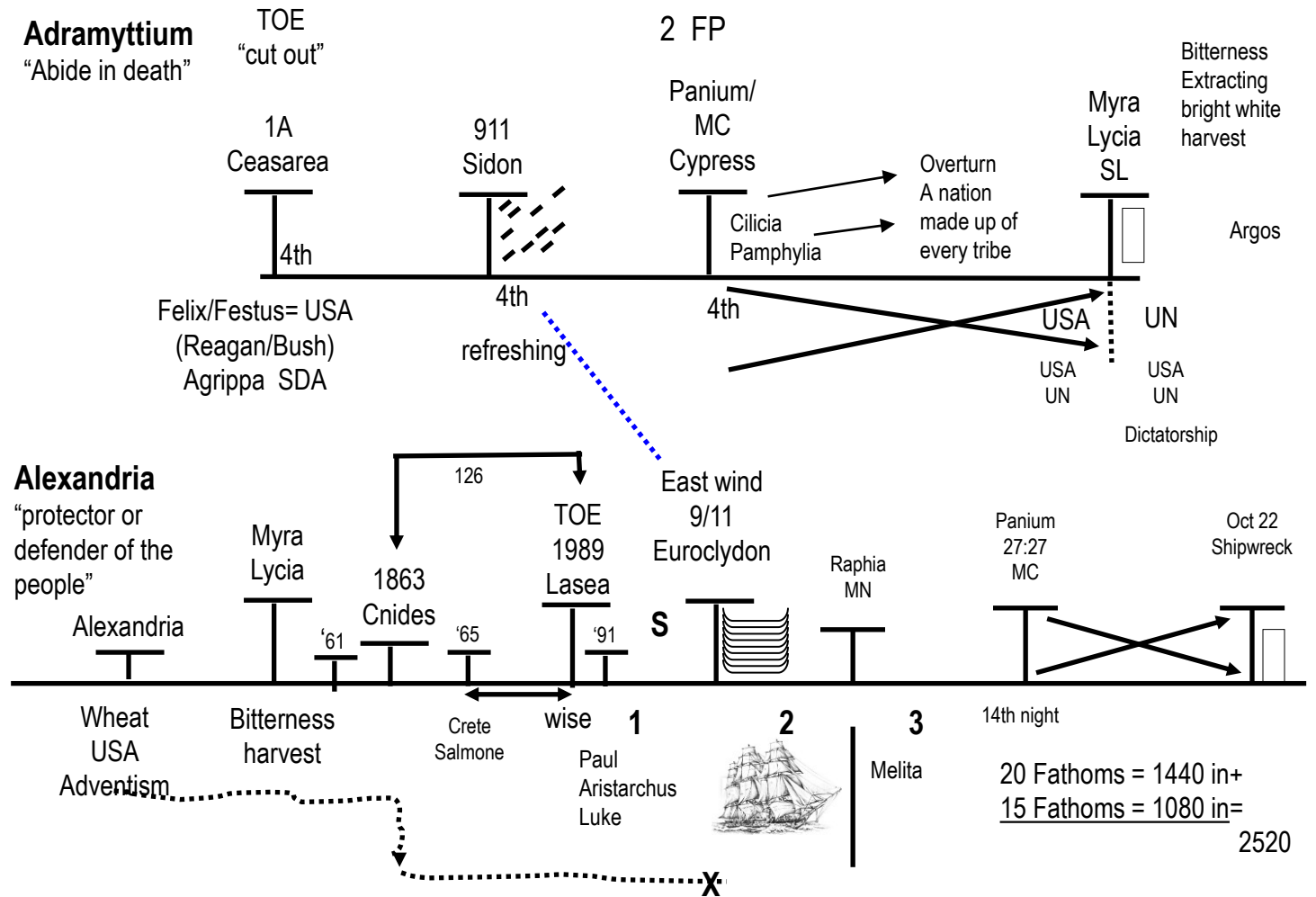

**Adramyttium**  
"Abide in death"

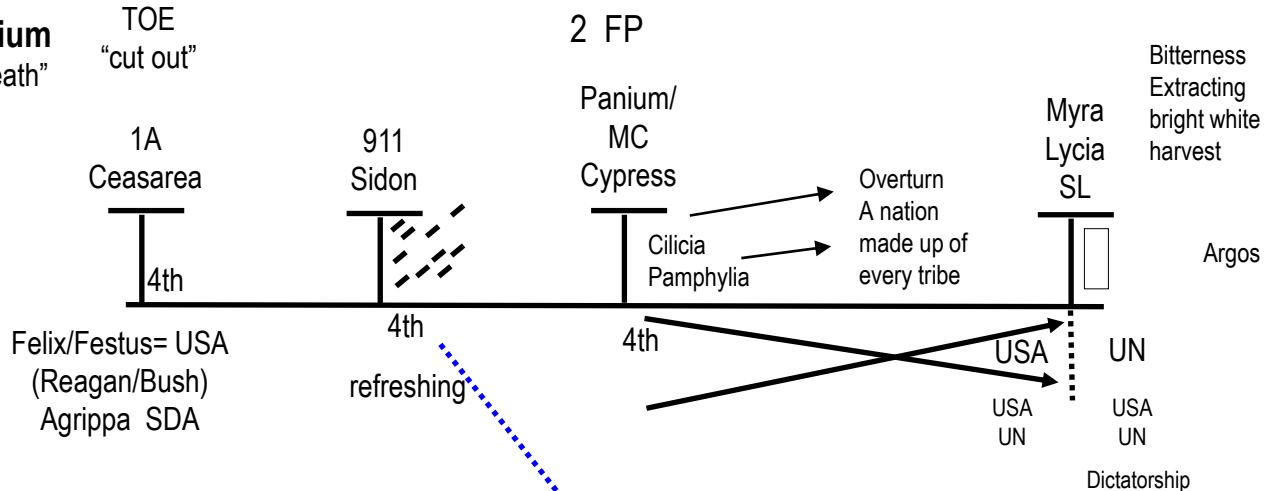

**Alexandria**  
"protector or defender of the people"

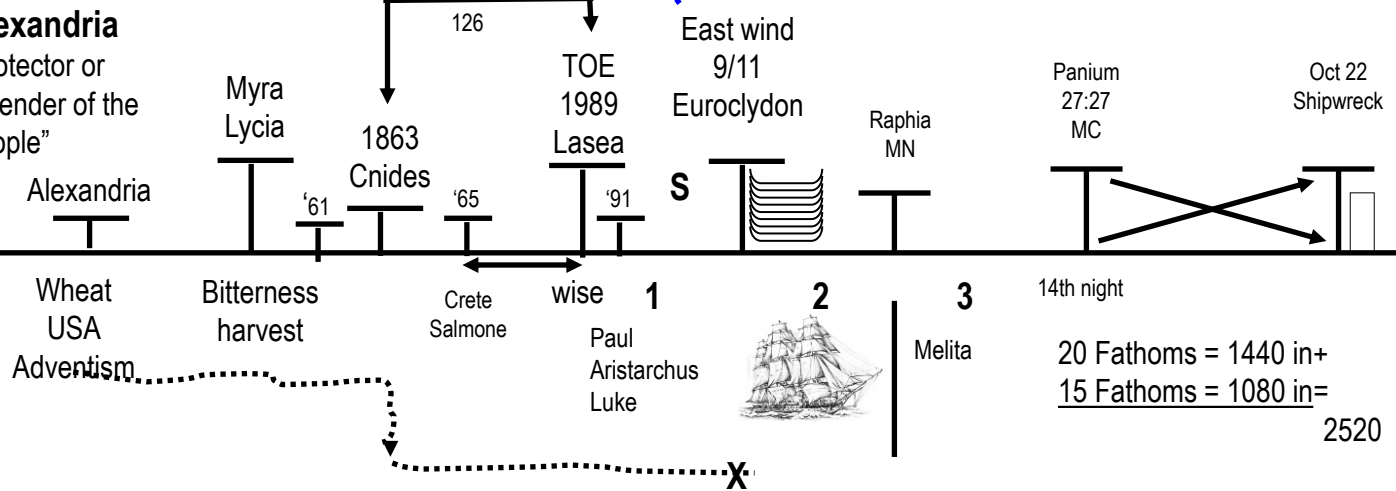

Then we come to our second line, we see these same institutions have protected and defended God's people from 1798. We want to understand what that protection and defense looks like and what the United States was meant to be. Was that protection and defense just for God's people, or was that liberty extended to everyone? Because we're saying it started in 1798 and at the same time, we see the rising up of Adventism with William Miller. It goes through 1844, and it loses its way in the middle of the Civil War in 1863, and goes off course, and never gets back to its original plan. We spent a lot of time in this movement, rightly so, going back and understanding what Adventism was meant to be.

In our later classes, we'll go back and consider what the United States was meant to be. Perhaps we can have a little bit more clarity in understanding at least what it was not meant to be.

It comes to 1989, and it's the story of the wise, the parable of the 10 virgins begins to be repeated. Paul tells them that they're in danger if they go on the course that they want to take. His warnings were ignored in Caesarea. They were ignored in Lycia. They set sail anyway. There's a favorable south wind, but the south wind blows before the east wind. So it also should have been a warning. We traced in that history the King of the South. Was that wind good or bad for the ship? It was favorable. It was the wind that they wanted to have to go on the course that they wanted to pursue. So for the United States and Adventism, they're happy about this fall of the King of the South. But if the King of the South is going to cease from restraining them, you know that the east wind is going to come, and that is another restraint. The south wind precedes the east wind.

The east wind or known as Euroclydon, it struck the boat, we mark that as 911. The boards begin to pull apart, the boat is flooding, they do this work to tie the boat back together again, and we described that as the wrapping of rope after rope around the boat, and we visually represented that as a "line upon a line". Ellen White tells us, the reason the boat is safe, is because Paul is on board. God had promised to preserve his life, because he has a job function. If he was to die in this history, he would not fulfill his job function, so the boat must be preserved.

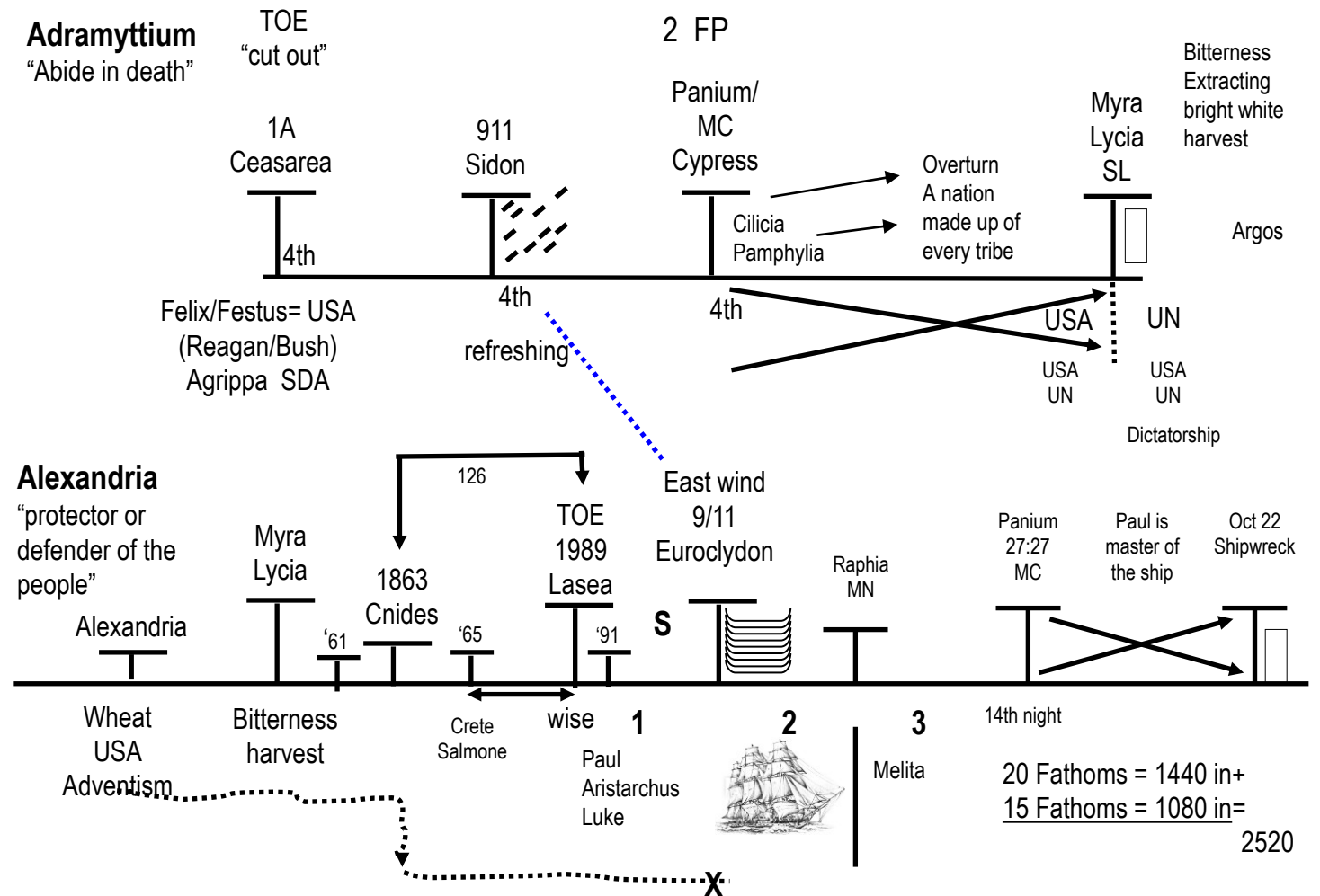

**Adramyttium**  
"Abide in death"

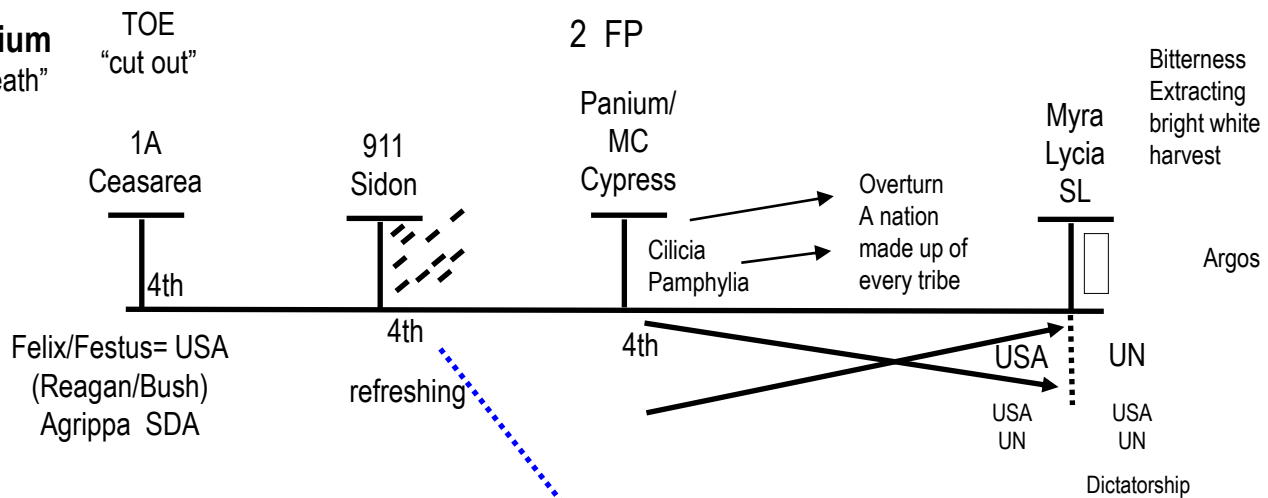

**Alexandria**  
"protector or defender of the people"

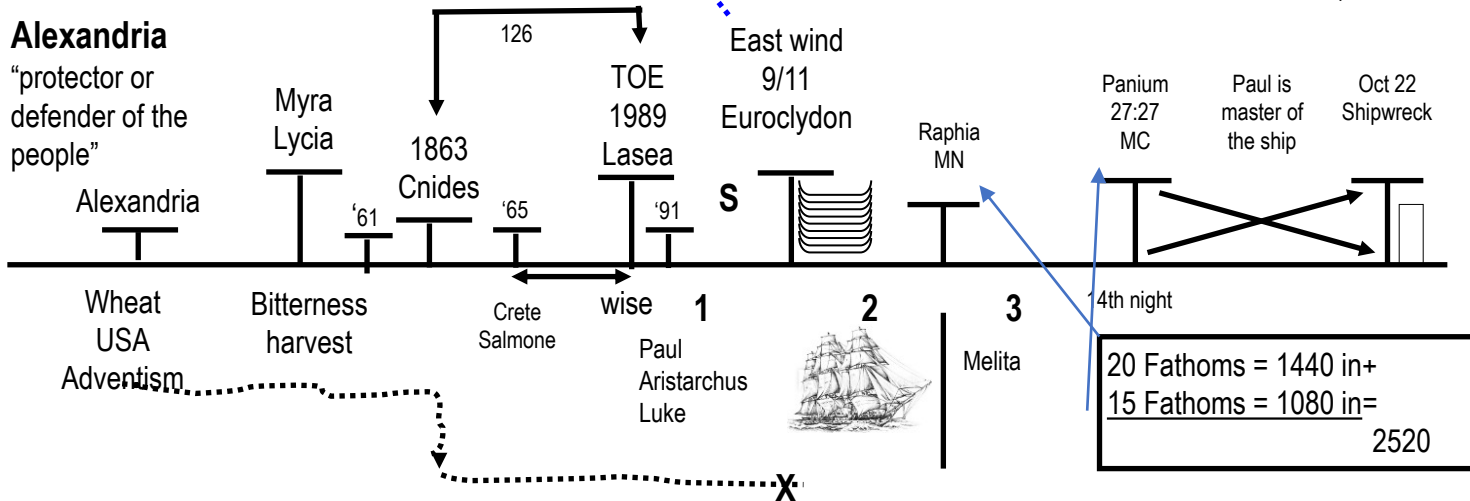

We come to a point in time, Paul is given a message, a warning begins for the boat. Your going to be ship wrecked. Then on the 14th night at midnight, **they can see it visibly ahead. Now they have time connected.** They sounded some distance (fathoms). So they have some concept of how far away they are. They at least know it's close. We mark that as "Midnight" and the "Midnight Cry". We mark Acts 27:27, as the midnight cry, because we're given repeated allusions to Millerite history. We can tie that to Cyprus, we can see midnight, the cry that would have gone up over the boat, the 14th night of the Exeter Camp Meeting, and a weaker logic but often connected 27:27, a doubling.

It's here in this history, after that cry, Ellen White notes that Paul is the master of the ship. You see his presence before, but it now has visibility. This all adds up to shipwreck which is the Sunday Law.

And here they go to the third group. All those on board the boat, Adventism are cleansed, so that by Sunday Law you have a solid group, purified, united, that are ready to give a message to the island. And we know that there's some on that boat who did not accept Paul's message. So shipwreck is Sunday Law.

The last thing we discussed, is that Panium is the Midnight Cry, what are they crying about? Is it for these groups of people, or is that cry about the condition of the ship? We are saying that it is about the ship, the institutions and structures. This cry is not for people. It's for the ship itself. There is a cry before shipwreck, which is the "Midnight Cry", and then the "Close of Probation", a shut door.

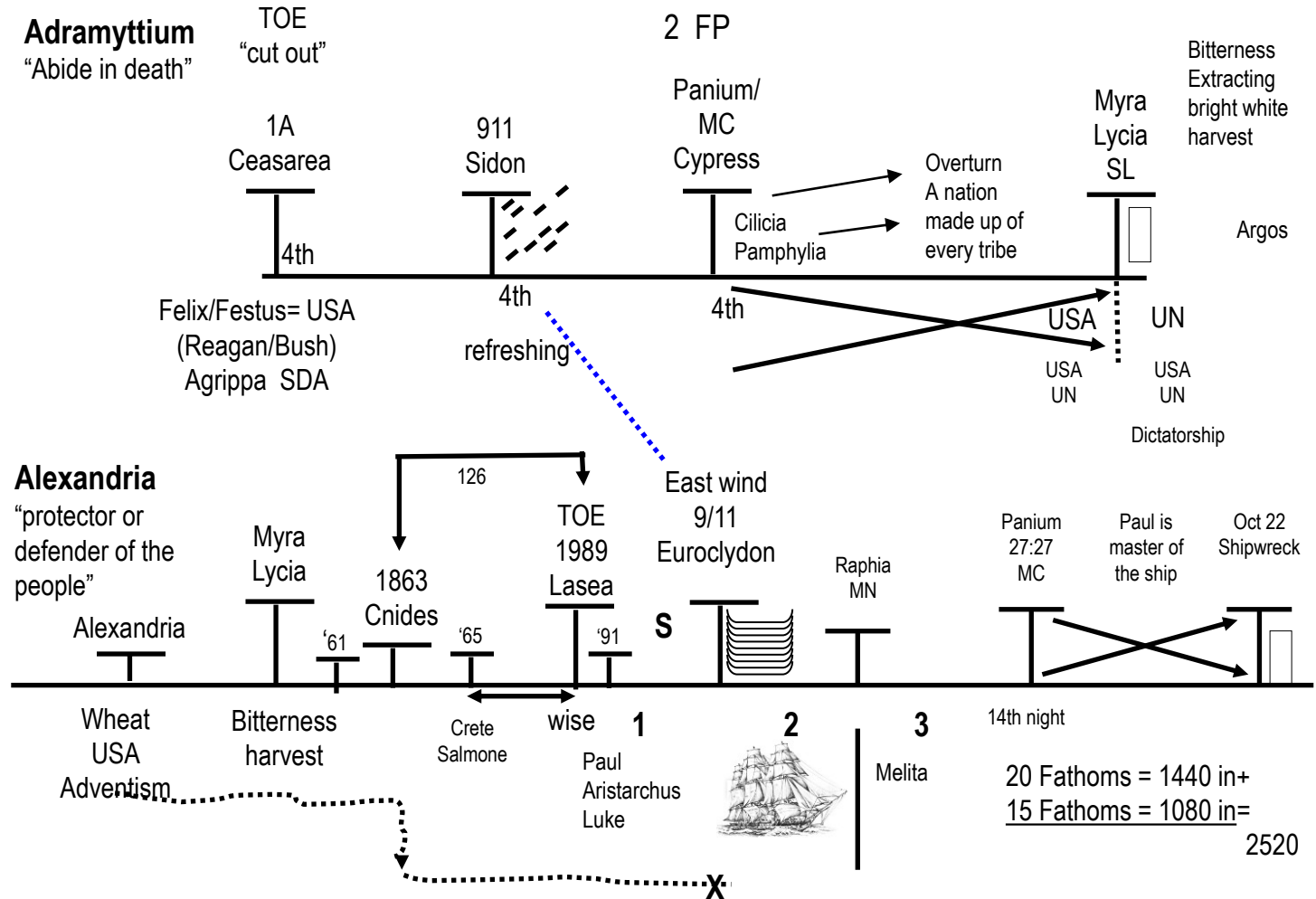

The last detail in this chapter, what connects us to our next subject, is to consider this second group of people. We have Paul, Aristarchus, and Luke. What does Aristarchus mean? It means “the chief prince”. Ellen White says in her writings, that he had accompanied Paul as an active choice. He was not tied to this ship, he did not have to be there, but he made a choice that he wanted to go on this journey so he could act as a support and encouragement to Paul. Who is the chief prince who goes on this journey as an act of choice? Christ.

What about Luke? What does his name mean? “Light giver” or “light bearer”. So he illuminates, but does he speak of himself? We deduced in verse 2 that he is there, he speaks of us but he doesn’t describe or speak of himself. He’s not there to give his own story, but he is giving the history, and that is the work of the Holy Spirit.

So when we talk about the first group, we see Paul. He’s the one speaking, giving the message at Caesarea, Lycia and at the Midnight Cry. But he is accompanied by Aristarchus and Luke. They are there as a choice, and they’re there to give a message to the ship.

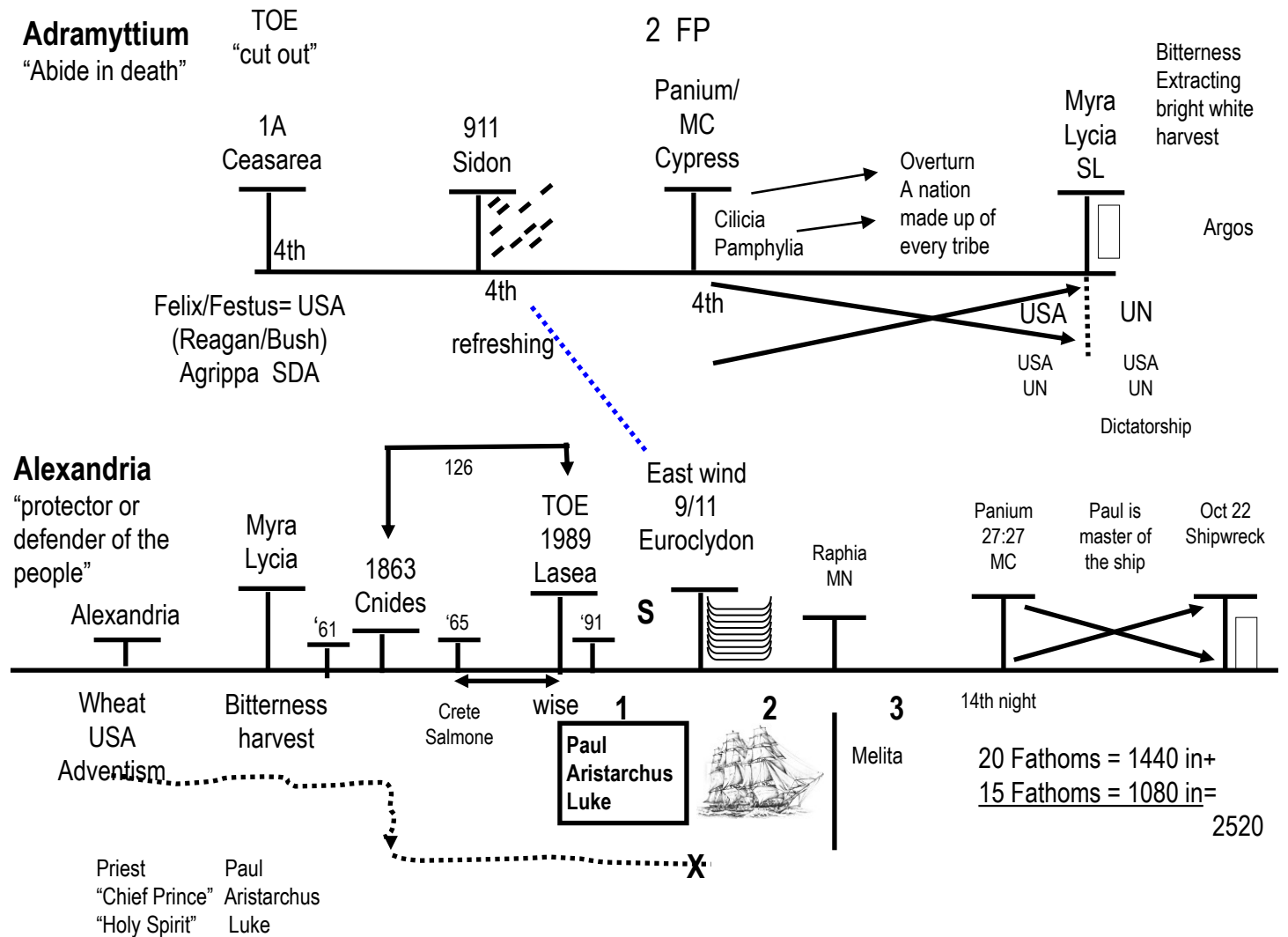

**Adramyttium**  
"Abide in death"

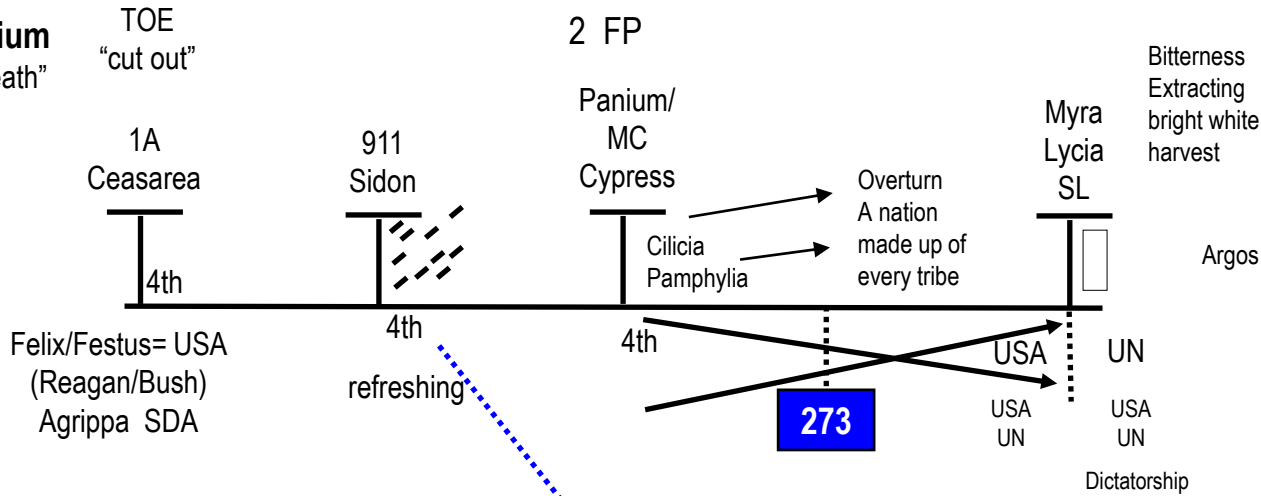

**Alexandria**  
"protector or defender of the people"

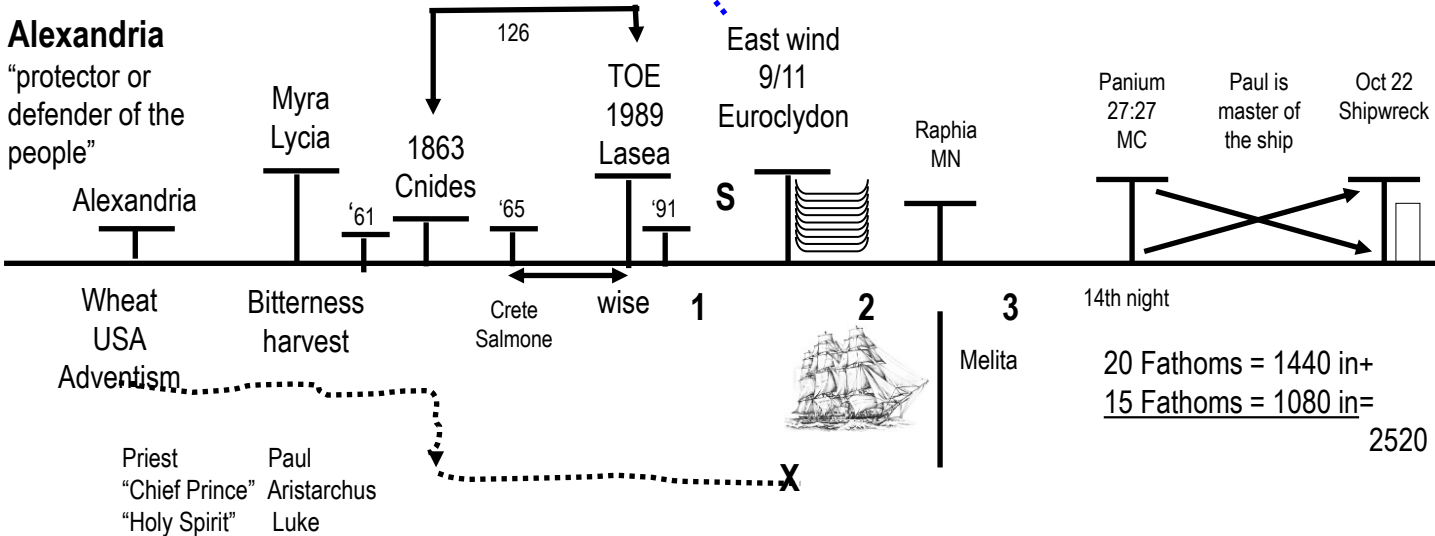

Acts 27:37 And we were in all in the ship **two hundred threescore and sixteen souls.**

This is the history between the Midnight Cry and shipwreck. It is at this point that Luke chooses to tell us how many people are on board this ship. Paul has been on it since 1844, at Myra. So he went through all this history. It's not until this point in the chapter, that what appears to be completely random, that we are given the number of those on board. And Luke says, "by the way, there's 276 people on board". But we are talking here about our second group, in a time period between Panium and Sunday Law. What group is the subject between Panium and Sunday Law? Levites, because this is their harvest. This is the subject (Levites). And he says, in this history (between Panium and Sunday Law), in the middle of it, he is choosing to tell us how many people. So if there is 276 people, how many of those are going to represent the Levites? Because this includes both groups, it includes the first and second, but it is in the time period of the harvest of the Levites. So we need to take the 276, and minus out Paul, Aristarchus and Luke. How many does that leave for our second group? Here there is 3 (Paul, Aristarchus & Luke), our second group consists of 273 people. Those are the people in this history deciding whether they accept the message of Paul or they reject it.



When we come to inspiration, one thing we see more and more of is that there is no information wasted. God uses a small amount of space to tell us all that we need to know:

- About what He wants from us
- To reveal Himself
- To explain the external events

Because we can only take in so much information.

So when we come to inspiration, is any of those details wasted? Any of that space? What we see more and more is that none of it is wasted, and it has importance for us. We take the number 276, it's teaching us of two groups within Adventism. There's 3 priests, and we have already identified them. Cut them out, and that leaves us with 273 Levites.

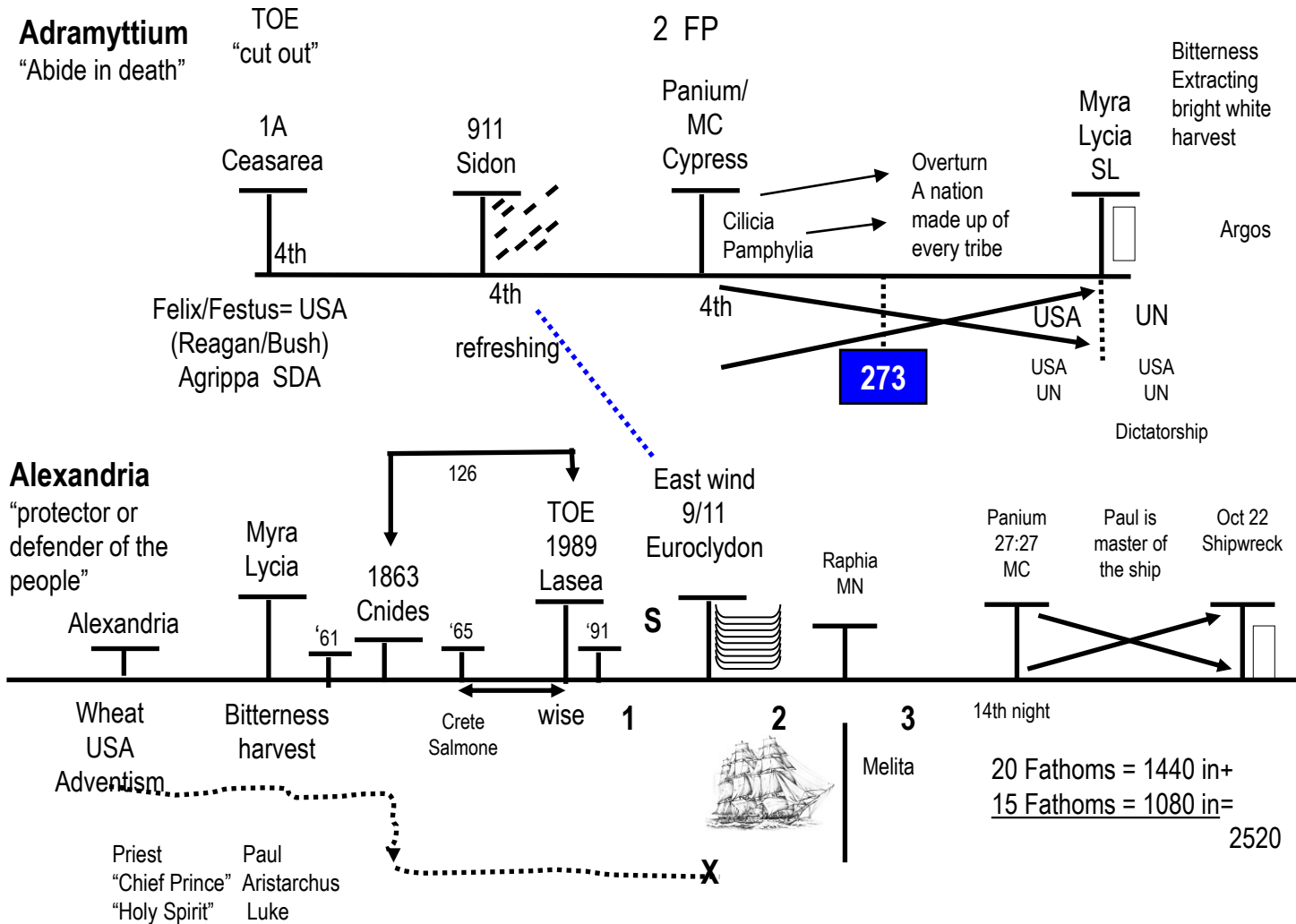

**Adramyttium**  
"Abide in death"

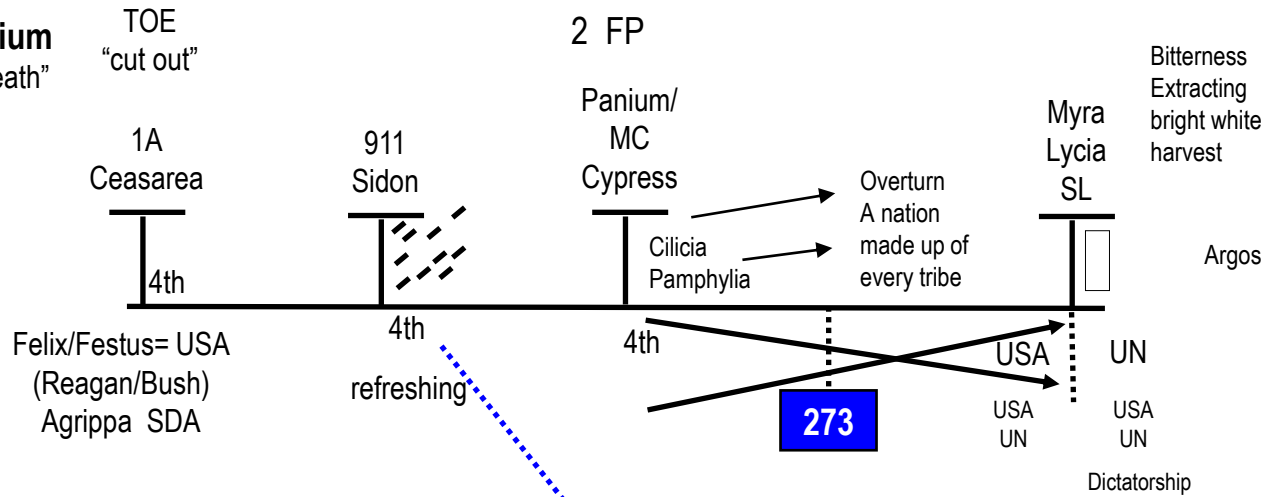

**Alexandria**  
"protector or defender of the people"

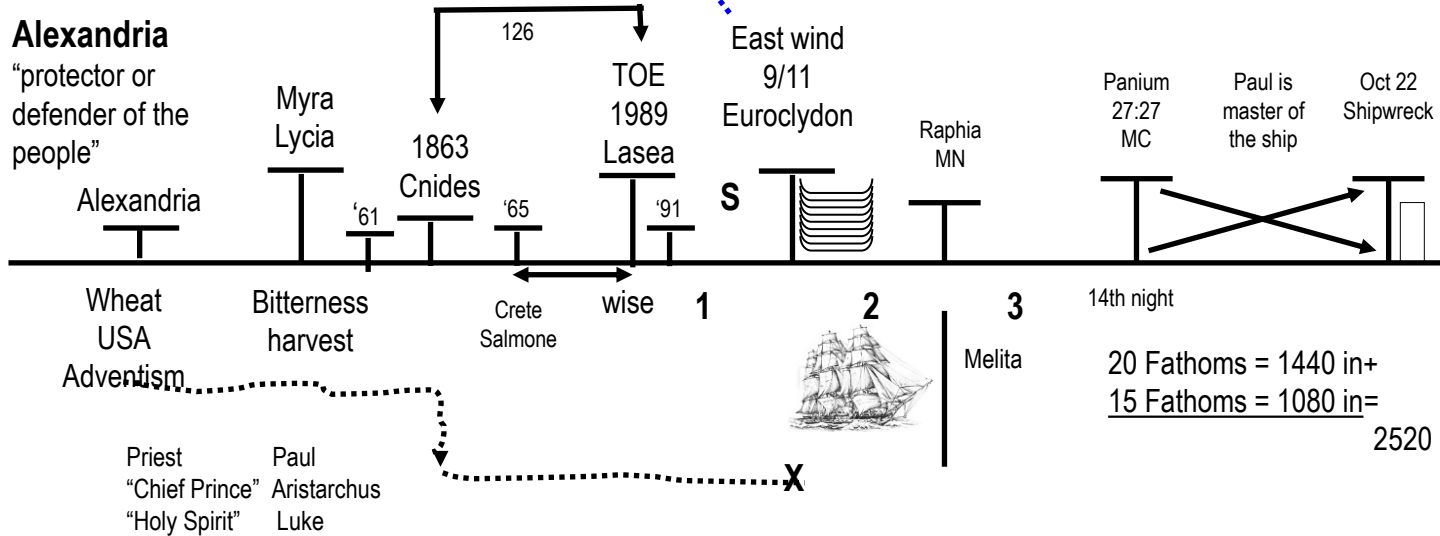

Num. 3:12 And I, behold, I have taken the Levites from among the children of Israel instead of all the firstborn that openeth the matrix among the children of Israel: therefore the Levites shall be mine;

3:13 Because all the firstborn [are] mine; [for] on the day that I smote all the firstborn in the land of Egypt I hallowed unto me all the firstborn in Israel, both man and beast: mine shall they be: I [am] the LORD.

3:14 And the LORD spake unto Moses in the wilderness of Sinai, saying,

3:15 Number the children of Levi after the house of their fathers, by their families: every male from a month old and upward shalt thou number them.

God is telling Moses that instead of the firstborn being chosen for the service of the sanctuary, He's choosing the tribe of Levi. So then if we follow through that chapter, it's going to give all the details of the numbering. The difficulty they're facing is to replace those firstborn, every single firstborn must be replaced. The numbers need to match. You can't have a firstborn who's not replaced in the service of the sanctuary. They're going to number the Levites, and then they're going to number the firstborn. How many Levites do they have?

Num. 3:39 All that were numbered of the Levites, which Moses and Aaron numbered at the commandment of the LORD, throughout their families, all the males from a month old and upward, [were] twenty and two thousand.

So they number the Levites and it comes to 22,000.

Num. 3:40 And the LORD said unto Moses, Number all the firstborn of the males of the children of Israel from a month old and upward, and take the number of their names.

3:42 And Moses numbered, as the LORD commanded him, all the firstborn among the children of Israel.

3:43 And all the firstborn males by the number of names, from a month old and upward, of those that were numbered of them, were twenty and two thousand two hundred and threescore and thirteen.

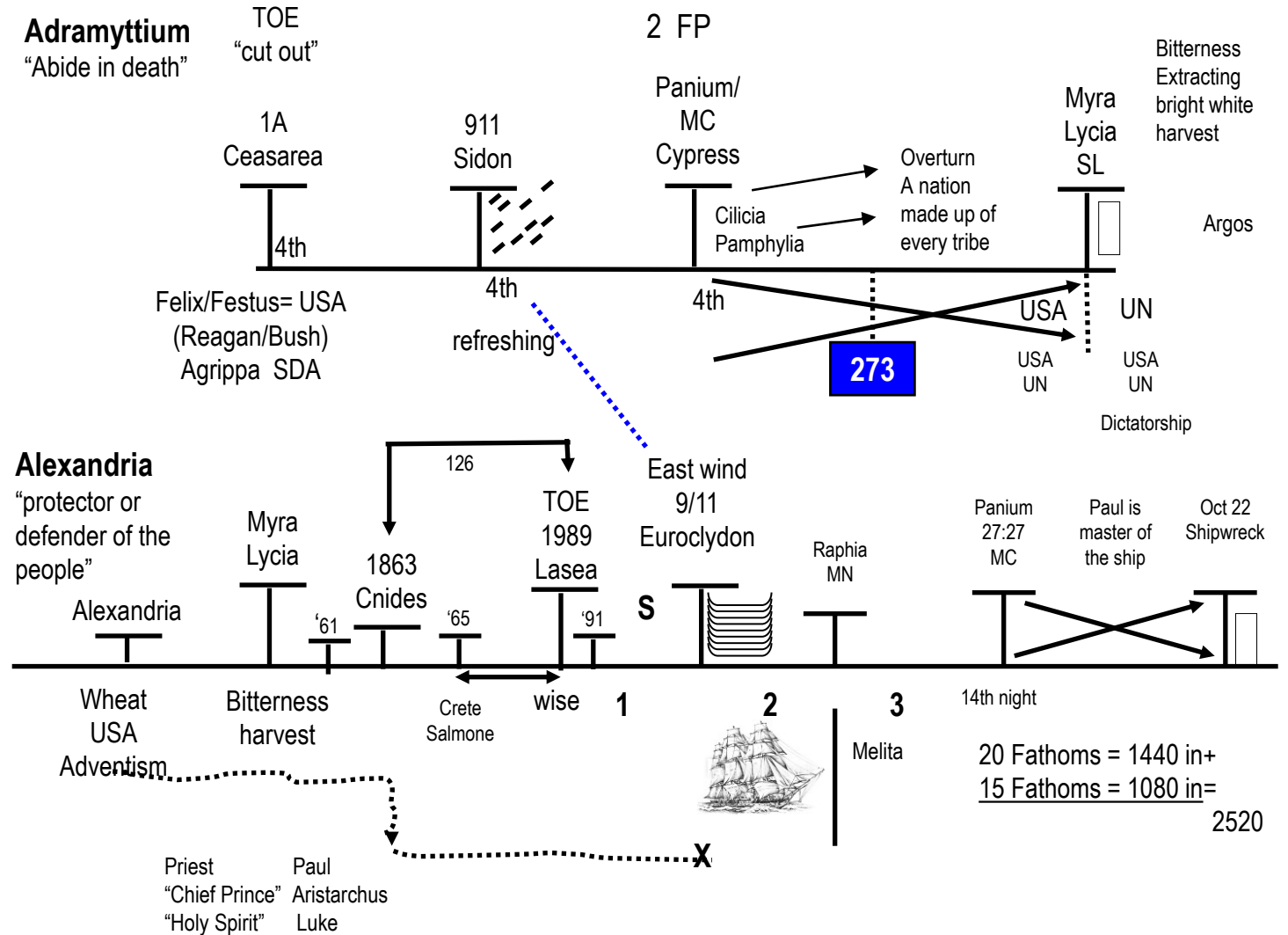

There's 22,000 Levites, how many firstborn? 22,273. What's our problem?

Levites	22,000
Firstborn	$\frac{22,273}{273}$

**Adramyttium**  
"Abide in death"

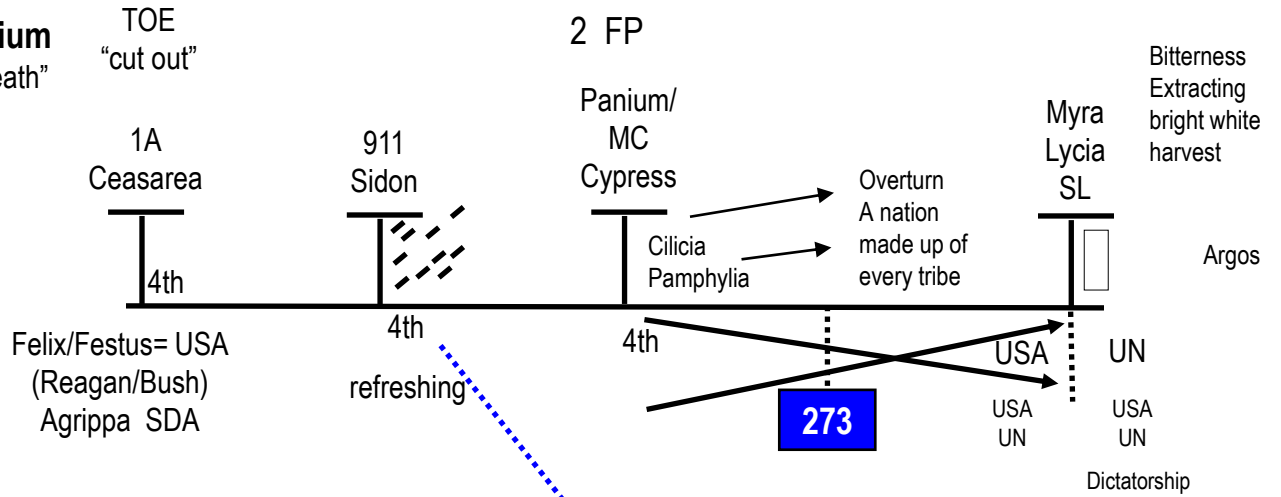

**Alexandria**  
"protector or defender of the people"

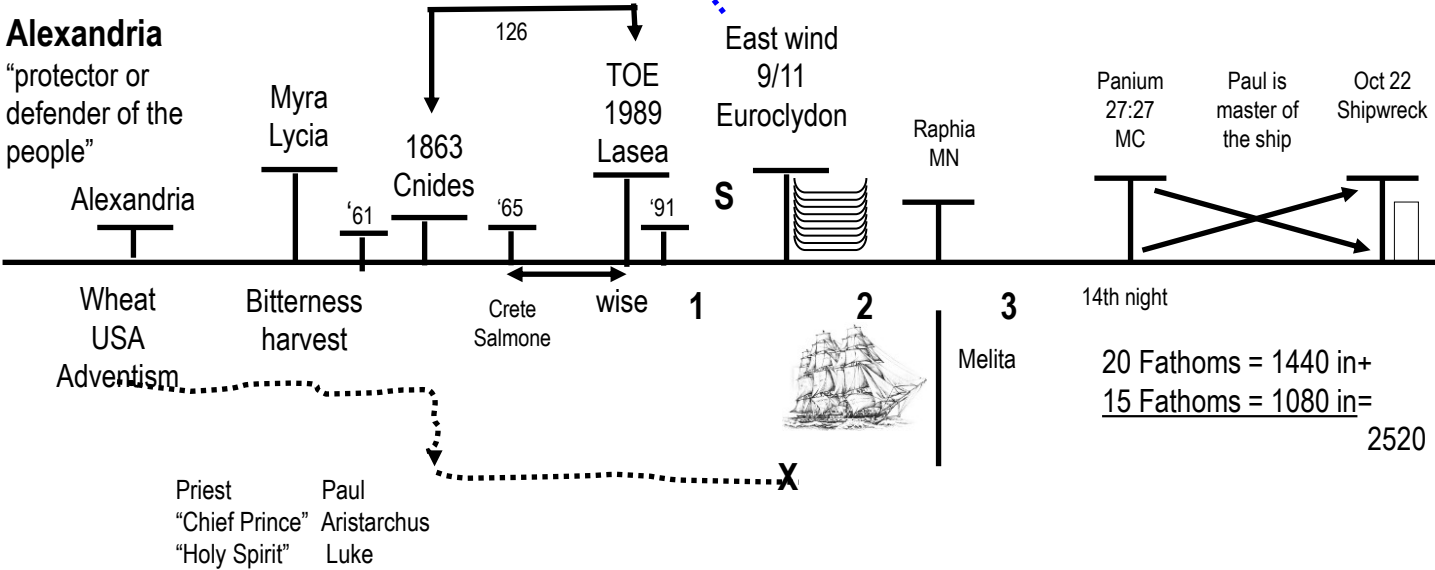

There's 273 too few Levites to fulfil the service of the sanctuary. When we go to Numbers 3, we are talking about their very beginning when they are first called. When we talk about Panium to Sunday Law, we are talking about their very end when the Levites are called. They are called in the beginning, they are called at the end. When they are first called out, there is a problem because there's 273 too few to fulfil their job function. So what happens at the very end? 273 Levites are called in to fulfil their job function. The number is completed or made up. At the very beginning there isn't enough and they must be replaced man to man. At the very end that situation is resolved, and the number becomes perfect.

Where this number takes us, is in some way different. It's going to take us into a period of history to 273 BC. We're familiar with numbers in the Bible now, that they can take us into a period of history. We do that with Deuteronomy 18:18. We see that as 1818 with William Miller. We are going to do that but from the other direction. We are going to look at 273 BC. What we are going to see is that 273 BC takes us to a period of history that is illustrating a time period between Panium and Sunday Law, into that same period of history.

**Alexander dies  
323 BC**

We are going to take the number 273 into a period of history. This is the history of Pyrrhus. You have probably heard of us speak of this king, and again we've gone into more detail in other studies late last year. We will go through it fairly quickly so we can spend some time in these studies dealing with the lessons we learned from it. We're just going to cover the history of Pyrrhus.

323 BC, the death of Alexander the Great; so when we go to 273 BC, it's closely connected with that history. We're going to consider the breakdown of Alexander's Empire and the generals that arose in that history.

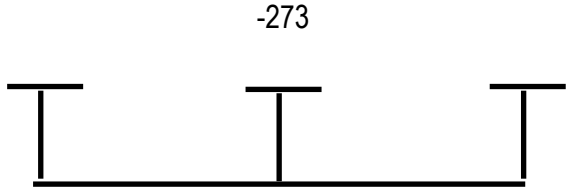

We'll paraphrase a couple of quotes. This is from the writing of A.T. Jones, "The Great Empires of Bible History" page 220 paragraph 1: He says that the reputation of the Romans was now growing in 273 BC because they've just fought a six-year war with Pyrrhus. So in 273 BC, A.T. Jones starts introducing the history of Rome. What he's saying in this history is that Rome begins to be noticed by foreign nations, in particular by Egypt. This is taking us to the history of the first rise of Rome. Before 273 BC, it worked in relative obscurity. People weren't taking much notice of the activity of Rome, at least within the Greek Empire, and the breakup of that Empire. Egypt, Babylon, Seluecus, Ptolemy, all of those generals. No one was paying much attention to Rome. But there's a six-year war between Pyrrhus and Rome and because of that war, Egypt sends Ambassadors to Rome. Egypt sends over ambassadors in 273 BC.

We'll paraphrase another quote, this is a book called "A Critical History of Early Rome". Prior to this history, there is a 6 year war between Pyrrhus and Rome, and it's known as the Pyrrhic War. There's 3 battles that all take you to the last and final battle in 275 BC, the battle of Beneventum. So it places Beneventum, the end of this war, in 275 BC. A couple of years later in 273 BC, Egypt recognizes the rise of Rome. In 272 BC, AT Jones says the following year Rome sends Ambassadors to Egypt. In 275 BC, you see the end of a war, a 6 year war known as the Pyrrhic War, and this was Pyrrhus fighting Rome.

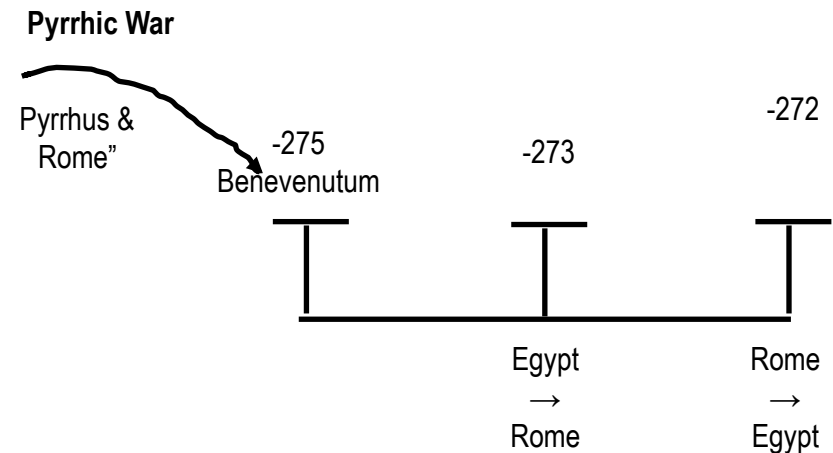

To recap that history quickly, we'll use a map of Italy, ignore the details, we just want us to see and make a point. Here is Rome in the North. And prior to this war with Pyrrhus, you would notice, that they have control over the North. Battle by battle, they have taken control over the North of Italy. So just prior to this history, they have the North, and if they want to expand anywhere else, it's going to be into the South. But the South is populated differently than the North. It is composed of Greek city-states. You would think of states like you would consider Athens and Sparta. They're fairly independent but they have a close family connection and that is how the South is populated. There is one city-state, Tarentum, that has a sphere of influence over the rest of the city-states in the South. There is one other city-state, Thurri. It's on the other side of the bay of Tarentum.



So as Rome begins to push south, it is aimed at this dominant city of Tarentum, and it ends with Tarentum and Rome going to war. Tarentum is not strong enough to defeat Rome alone. So they ask a relative of theirs, down in a little country in Epirus. Epirus is bordering Macedonia. They ask the king of this country (Epirus), to come over to Tarentum and fight this war with Rome on their behalf. This king is known as Pyrrhus, and he agrees. In 280 BC, he sails over to Tarentum and then he fights against Rome. This is the Pyrrhic War.

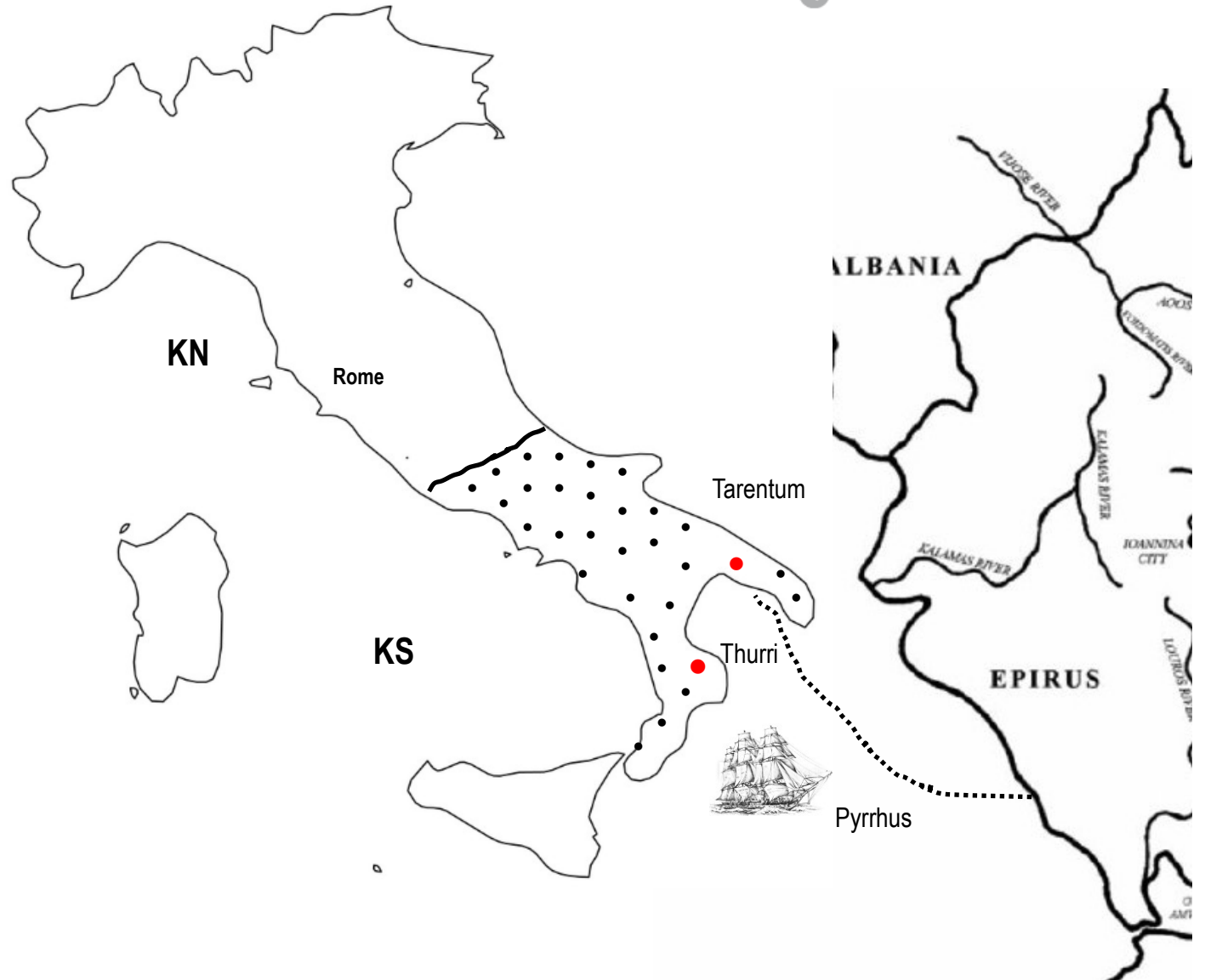



## Pyrrhic War

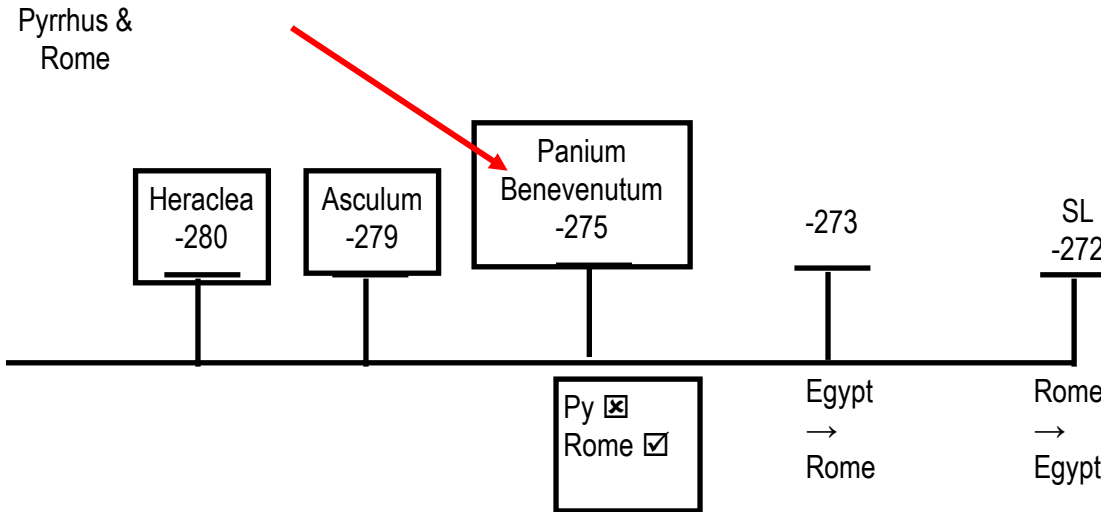

3 Battles, 280 BC, 279 BC, and 275 BC. This is the battles of Heraclea (280 BC), Asculum (279 BC), and Beneventum (275 BC). 6 year Pyrrhic War. In 275 BC, Pyrrhus is defeated and Rome wins.

What we need to see, before we trace this history in greater detail, is that this is a story of the King of the North and the King of the South. The King of the North is Rome. The King of the South is Pyrrhus.

## Pyrrhic War

So what this history is going to trace for us, is this struggle between the King of the North and the King of the South that takes us to the battle of Beneventum, where the King of the South is finally defeated. If we were to give that battle a name with which we are more familiar with, we would call it Panium. 275 BC illustrates Panium. In the middle of this history, 273 BC, is the alliance between Egypt and Rome. Rome then returns that favor, and sends ambassadors in 272 BC. The chief ambassador is known as Fabias Maximus Gurges.

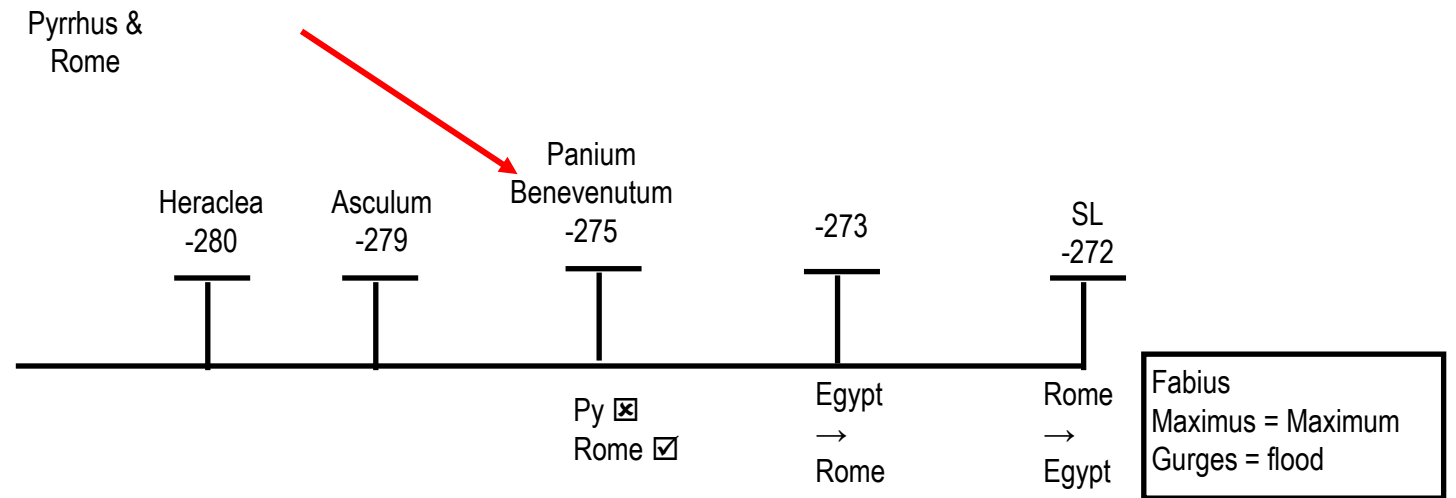

What does Maximus mean? Maxium.  
Gurges means flood.

What comes as a flood? The Papacy. When? At Sunday Law (272 BC). Rome comes against Egypt as a flood, not as any flood, but the maximum flood in 272 BC.

So 273 BC, takes us back into our same history between Panium and Sunday Law, and the story we will then trace, we want to understand who Pyrrhus is and his story. Because if we understand Pyrrhus, then what we are going to understand is the King of the South in our time in his story. We can already see those battles beginning to be illustrated.

We need to see is that this is all telling us the story of Pyrrhus as the King of the South. If we were to trace his history, it happens in 2 parts. An Alpha and an Omega. This is the history of Pyrrhus verses Rome, but it's the second part of his story. As a king he comes into our history soon after the breakup of Alexander's empire. And it's in those early battles that we see his first history. If we trace his life, there's 2 parts. First there are his campaigns in Macedonia, and then there are his campaigns in Italy.

# Pyrrhus

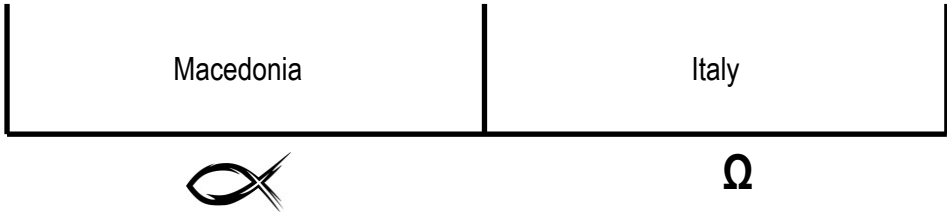

So when we come to our history, and we draw the line of Acts 27, where did we place the King of the South? In the second line, the ship of Alexandria, where did we place the King of the South? Panium. We identified Panium; we could say Midnight ... Midnight Cry, Raphia ... Panium. So there is a history here. Where else? Where else do we talk about the King of the South? We talked about the South Wind. What history is that? 1989, 1991 in this history.

So we can see the King of the South without going into the specifics of this which we are going to do in another study. We just want us to see that this is the history of the King of the South. It takes us to 1989 - 1991. Then we can mark a gap, then we know that we are going to have a second history of the King of the South. There is an alpha and an omega. We see the same dynamic with Pyrrhus. Macedonia and Italy. There is an alpha, and an omega. So if we are going to talk about the history of Pyrrhus, we don't just want to go back to the Pyrrhic War with Rome. We need to go back to the first history of Macedonia and see where he began his work.

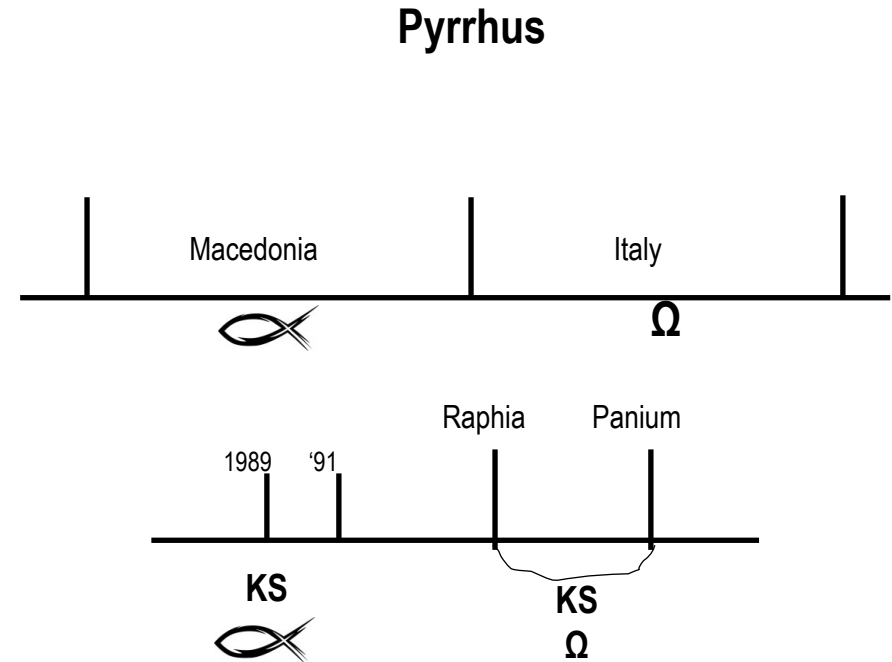

Dan. 8:5 And as I was considering, behold, an he goat came from the west on the face of the whole earth, and touched not the ground: and the goat [had] a notable horn between his eyes.

8:6 And he came to the ram that had [two] horns, which I had seen standing before the river, and ran unto him in the fury of his power.

8:7 And I saw him come close unto the ram, and he was moved with choler against him, and smote the ram, and brake his two horns: and there was no power in the ram to stand before him, but he cast him down to the ground, and stamped upon him: and there was none that could deliver the ram out of his hand.

8:8 Therefore the he goat waxed very great: and when he was strong, the great horn was broken; and for it came up four notable ones toward the four winds of heaven.

What history is this? We're talking about the he goat, the he goat has a notable horn. Who is that horn? Alexander the Great. It's interesting that it doesn't give another history for Greece. It's just interested in that one horn, Alexander the Great. When that horn is broken, it transitions into another kingdom. But this is giving the history of Alexander the Great, and his death. He died in 323 BC. Then what does the verse say happened? You have one horn and then what happens? It's broken, and then you have 4 horns. What are their names? Seleucus, Ptolemy, Cassander, Lysimachus. 1 horn is broken, 4 arise.

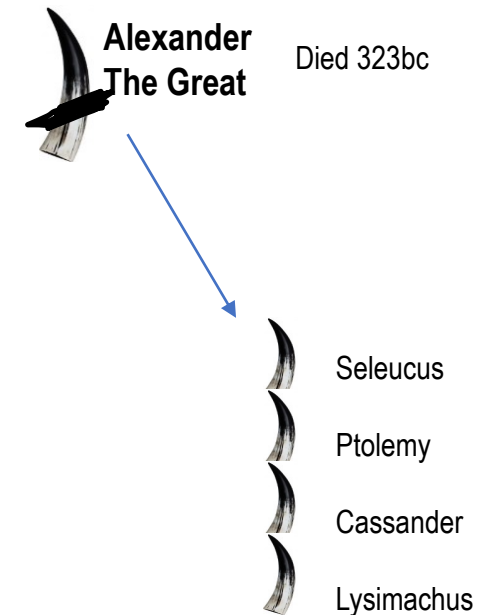

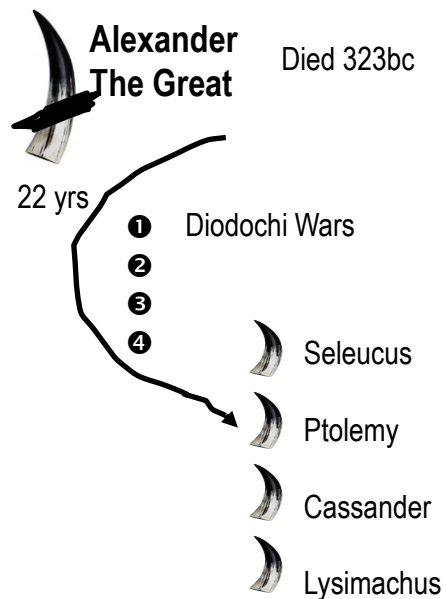

When we go into that history, historically, is it that simple? How many generals take over Alexander's empire after his death? Many. We haven't counted but there are many. At least a couple dozen. His empire is divided into many parts. These (Seleucus, Ptolemy, Cassander, Lysimachus) aren't even the most powerful. When Alexander the great died, Cassander was given nothing, he was only a boy. Seleucus had nothing. Ptolemy took Egypt. I think Lysimachus took something, but there were other generals. Perdikis, Antipater, particularly another known is Antigonos. There were powerful generals who took over Alexander the Great's empire. A few are the most powerful, and then the others who carved out little territories. It took 22 years from the death of Alexander in 323 BC to the rising up of these 4 generals (Seleucus, Ptolemy, Cassander, Lysimachus) in 301BC. So this is 22 years of history between the horn being broken and 4 horns rising up. 22 years that Daniel skips. In that 22 years, there are 4 wars known as the Diadochi. The Diadochi Wars, that divide up that empire. They will fight over it until just 4 are left (Seleucus, Ptolemy, Cassander, Lysimachus).

If we were to draw that on our reform line, we would say, 323 BC, the death of Alexander, and then we mark 4 wars, and at the end of the 4<sup>th</sup>, in 301 BC there is a famous battle and it's our 4 generals in an alliance against the last and 5<sup>th</sup> general. In 301 BC, there is the battle of Ipsus, and these 4 generals face the 5<sup>th</sup>. These 4 combined, are only equal to him in strength. That is how powerful this 5<sup>th</sup> general is - Antigonus.

In this 5<sup>th</sup> battle in 301 BC, Antigonus is killed, and we have our 4 generals marked. We only have those 4 generals for about 3 years. About 298 BC, Cassander dies. So 3 years later, you only have 3. There were 5 generals, Seleucus, Ptolemy, Cassander, Lysimachus, and Antigonus. 5 generals for a large part of this history, about 15 years. We skipped 22 years, 15 years of 5 generals, to pick up these 4 generals in 301 BC. In 298 Cassander dies.

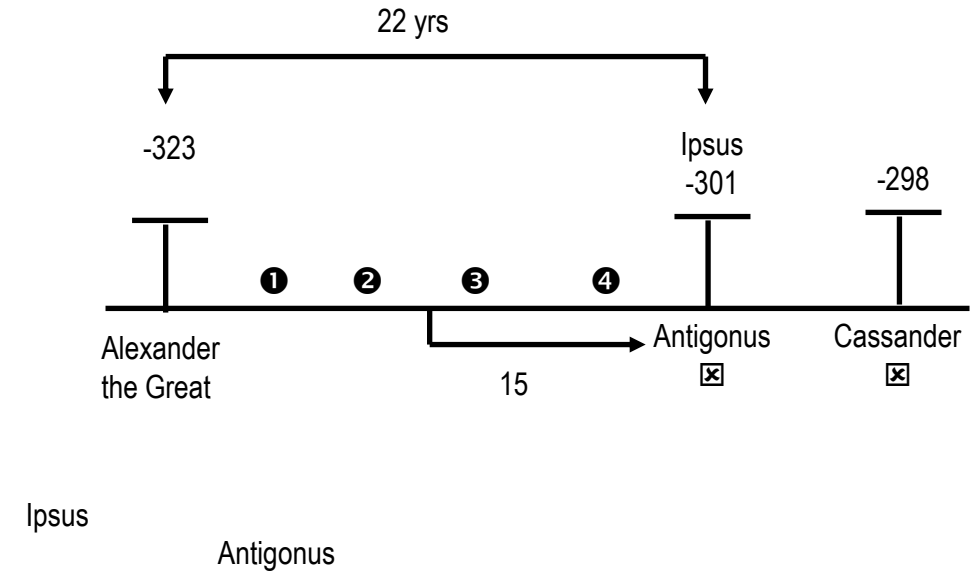
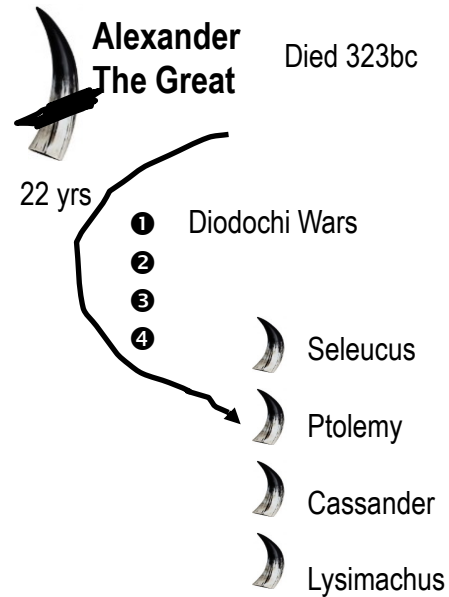

So if you were to take Daniel, this history, from the historian point of view, it's not naming what we might say is the significant parts of that history. What Daniel has done under inspiration, is go through the history of Greece, and take just the parts he wants to take, to make the prophetic point he wants to make. He goes from the death of Alexander, 323 BC, skips everything else, and he says that's noise. It's unimportant. We need to block it and just go from 323 BC to 301 BC, and mark the 4 generals. These 4 are famous in prophecy.

Pyrrhus comes into this history, in this 4<sup>th</sup> war just before the waymark of 301 BC. Pyrrhus is still young, he begins his political campaign, he's made king, and begins to work to create alliances to go into battle. He's young, about 16 or 17 years old. He's going to go into battle, the first of his battles marked in history, is Ipsus, where he first campaigns. So we want to consider that history, the beginning of Pyrrhus.

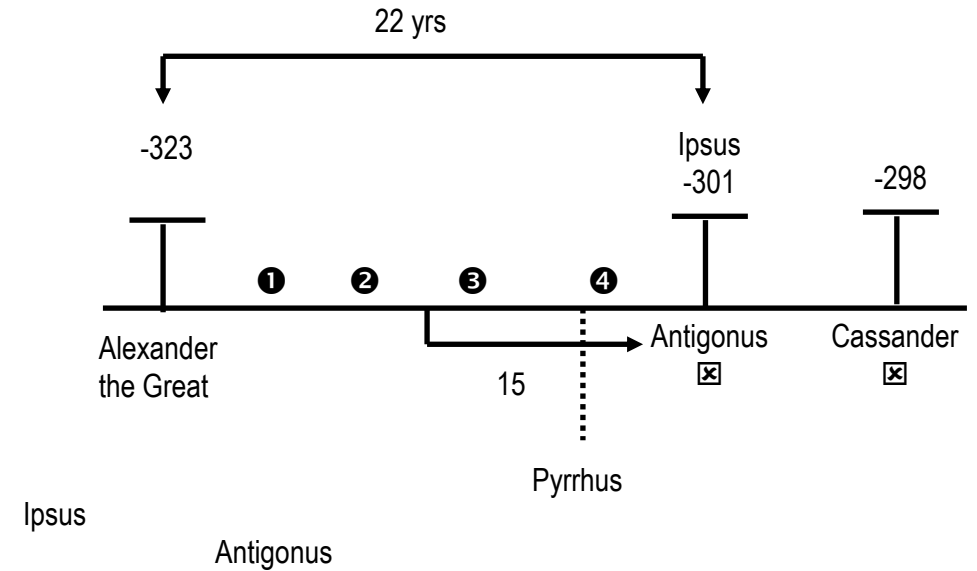
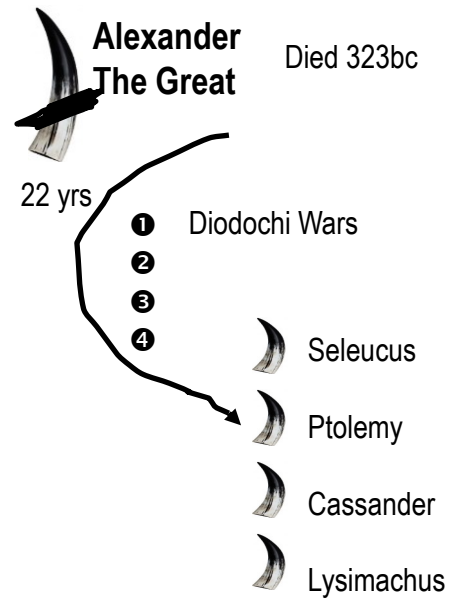



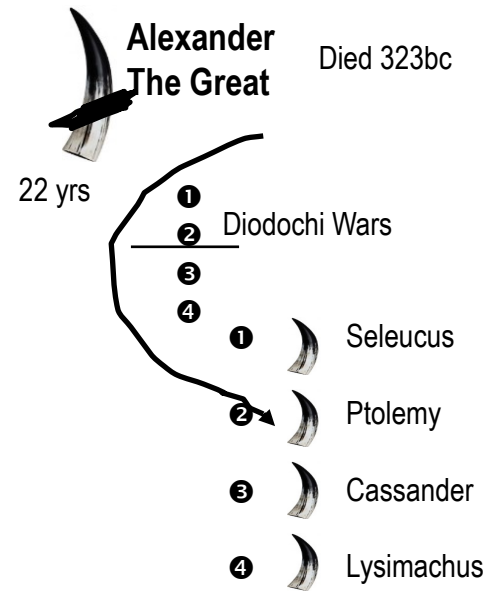

**Battle of Ipsus**

5  
Antigonus + Demetrius

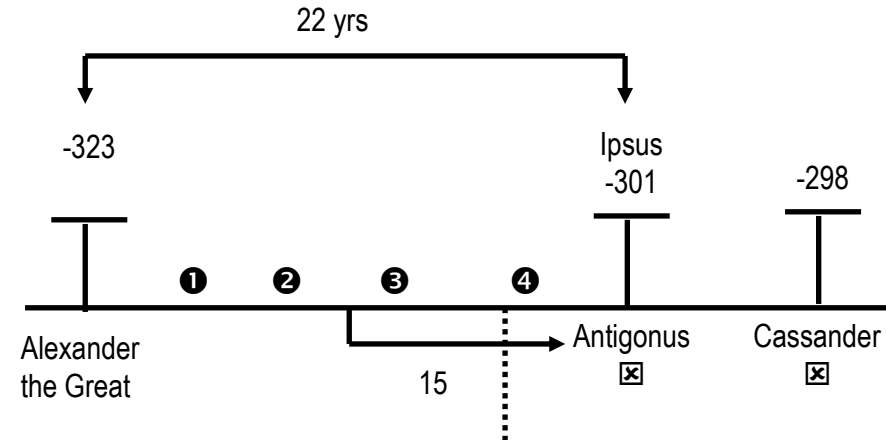

This 4<sup>th</sup> Diadochi War, actually the 3<sup>rd</sup> and the 4<sup>th</sup>, is this dynamic - these 4 generals against Antigonus. So for the first and second (Diadochi wars), you have the many generals fighting it out, and the 3<sup>rd</sup> and 4<sup>th</sup> have the same characteristics. 4 against 1, Seleucus, Ptolemy, Cassander, Lysimachus against Antigonus, the 5<sup>th</sup>. They fought in the 3<sup>rd</sup> Diadochi War, and neither side could completely wipe out the other.

The 4<sup>th</sup> Diadochi War, begins in 307 BC. We are talking about Antigonus, but there is another player that is important to mark. He (Antigonus) isn't alone, he has a son, and that son plays a significant role in the 3<sup>rd</sup> and 4<sup>th</sup> war, particularly in the 4<sup>th</sup>. That son is Demetrius. To discuss this history, we need to consider both, because Demetrius becomes our main subject. Antigonus and his son Demetrius. In 307 BC, Demetrius does something that is antagonistic against the 4 generals, he goes into Athens, defeats a dictator and frees it (Athens). Demetrius frees Athens. That dictator was placed there as a puppet of Cassander, 10 years previously in 317 BC.

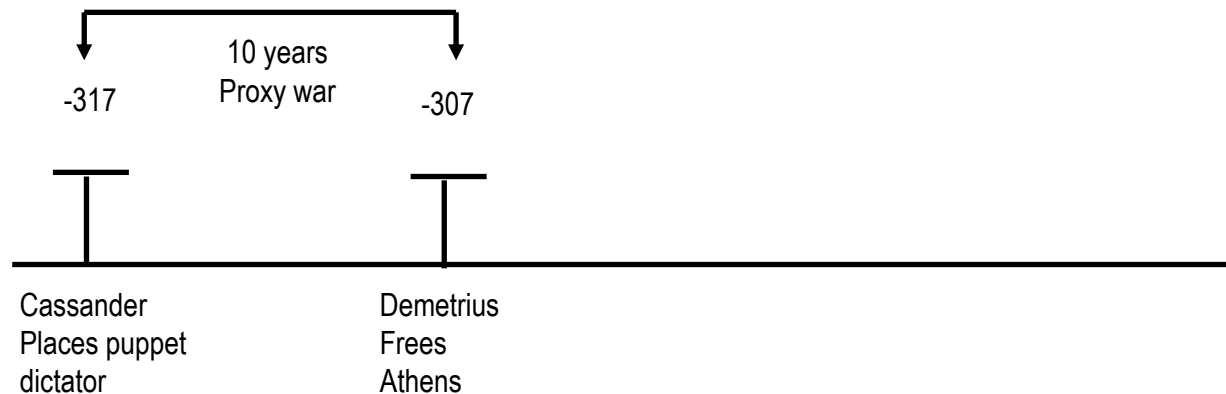

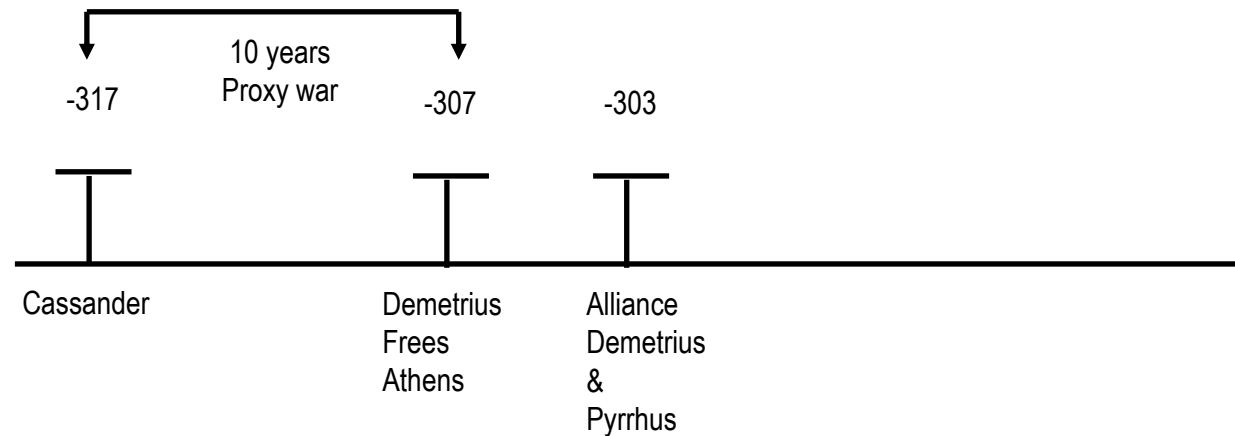

So in 317 BC, Cassander placed a puppet government in Athens designed to serve his interests. 10 years later, Demetrius frees Athens. This is a history of a proxy war. Athens is being used as a go between. Because of this, war begins again or the 4<sup>th</sup> Diadochi War between 4 generals and Antigonus. The 4<sup>th</sup> war begins (307 BC).

In 303 BC, an alliance is created. This is an alliance between Demetrius and Pyrrhus. This is where Pyrrhus enters the scene. Pyrrhus the king of the south, goes into an alliance with Demetrius. Demetrius is the son of Antigonus. They are the 5<sup>th</sup> player in that history.

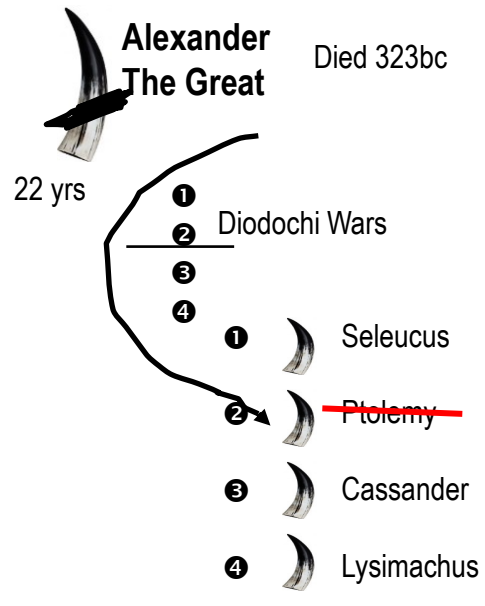

**Battle of Ipsus**

5  
Antigonu  
+ Demetrius

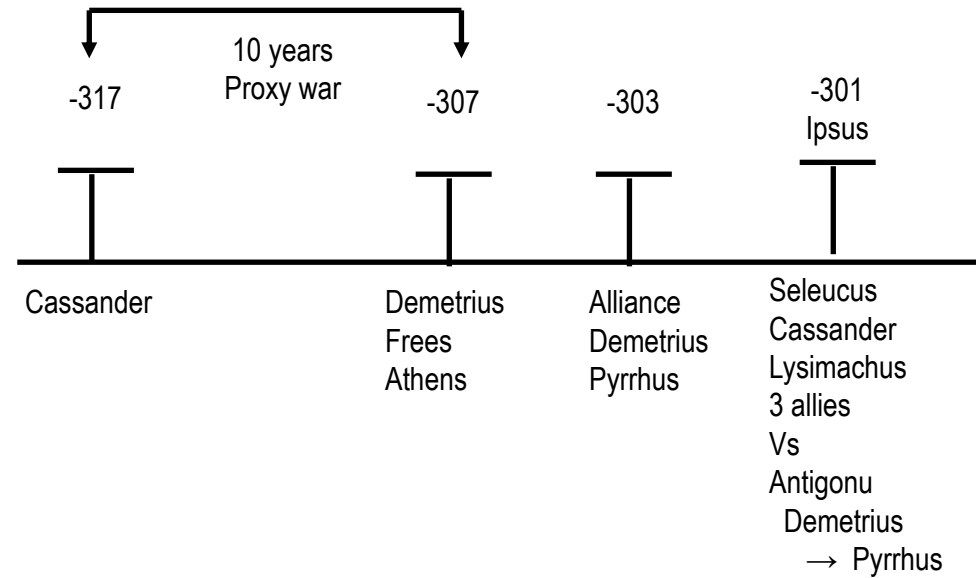

In 303 BC Pyrrhus' sister marries Demetrius, and Pyrrhus begins to act as a general of Demetrius. He fights as his general in just one battle, and this is the battle that we have been discussing: 301 BC, the battle of Ipsus.

In this battle (Ipsus), our 4 generals are in an alliance, and they are coming against Antigonu and Demetrius. Just prior to this battle, Ptolemy receives a fake report that it has already been fought and our allied generals have been defeated. Because of this, he flees back to Egypt, and does not take part in this battle. So when we come to the battle of Ipsus, there are 3 allies. They are known in history as the allied forces. Cassander, Seleucus, Lysimachus, and they go out to fight Antigonu and his son Demetrius. Demetrius has an important general, King Pyrrhus. So our three allies, against Antigonu and Demetrius, and Demetrius is supported by Pyrrhus, who is fighting for him in this battle.

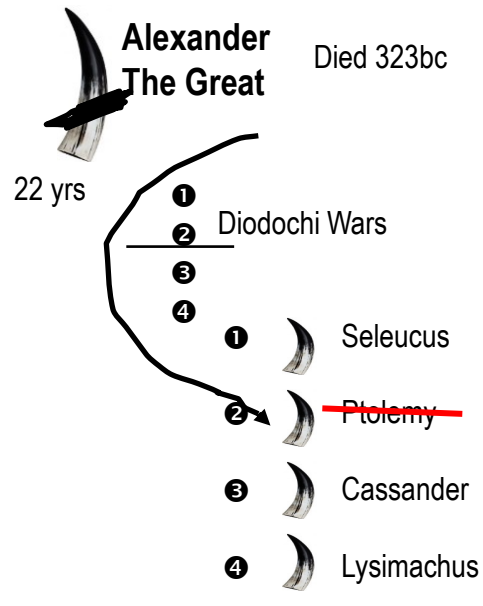

**Battle of Ipsus**

5  
Antigonu  
+ Demetrius

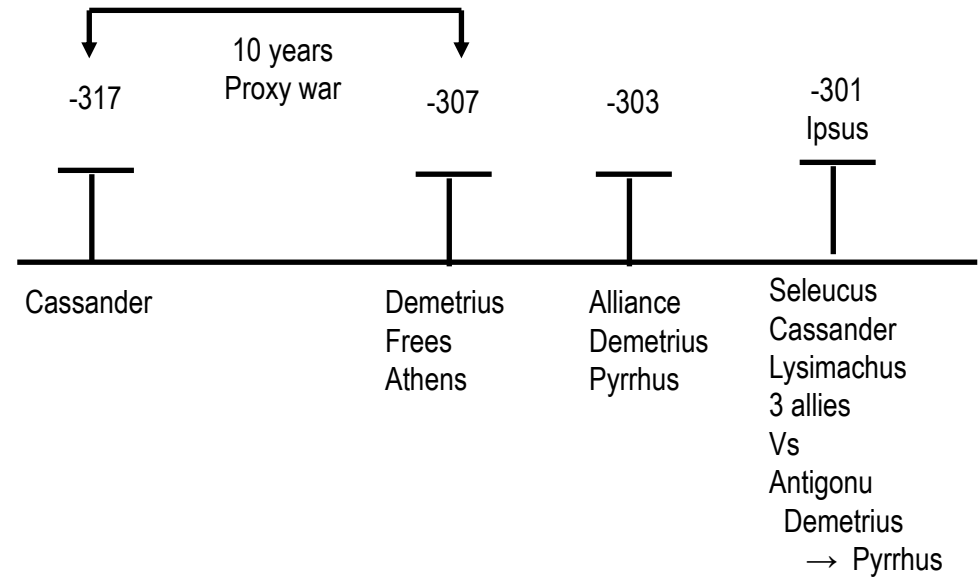

Antigonu is defeated and killed. Seleucus comes to this battle, he's returning from his eastern campaign. If you have read into the history of Seleucus, he went into the east, he was extremely successful, and because he went into an alliance with an eastern king, he returns at the battle of Ipsus with 400 or 500 war elephants. We don't know the exact number but it was immense. It is these war elephants that decide the course of this battle.

These three, Seleucus, Cassander, Lysimachus, draw out against Antigonu and Demetrius, and what Seleucus is able to do, is drive his elephants between them. Antigonu is isolated, and killed. Demetrius becomes king of that empire, most of it is lost to these three (Seleucus, Cassander, Lysimachus), but he has his own navy and land. He (Demetrius) flees but begins to rebuild.

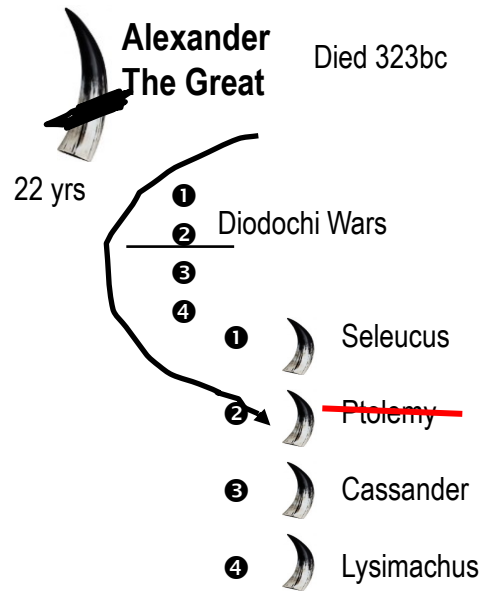

**Battle of Ipsus**  
⑤  
Antigonu  
+ Demetrius

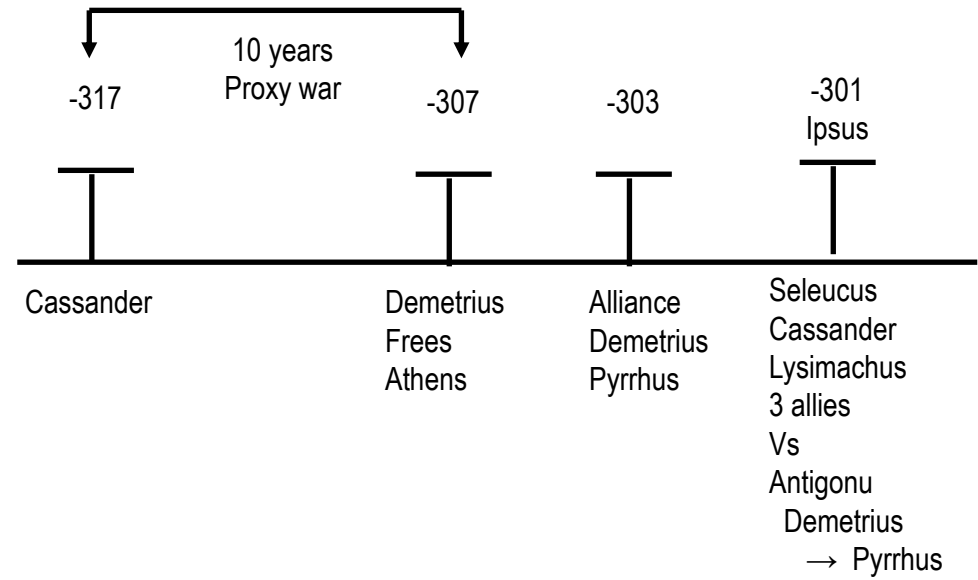

We'll close with a quick review. We have gone from Acts 27, into the history of Pyrrhus. We went there by going to 273 BC. We saw that 273 BC is the history between the battle of Panium and Sunday Law. The King of the South in that history is Pyrrhus. He has 2 histories connected with him. 2 separate campaigns, one in Macedonia and one in Italy. Without proving it, which we can do in detail and different ways, the king of the south in our history comes in 2 separate histories. A beginning and an end, an Alpha and an Omega. So when we consider Pyrrhus, we need not just go back to his campaign in Italy, but consider his campaign in Macedonia.

What we are going to do next time, is draw out both histories. We want to understand Macedonia and Italy. An Alpha and Omega of the King of the South, and then we want to bring them into our history, consider the king of the south in our time, as an Alpha and Omega. They all illustrate what is happening now, and in the near future.