

9T 11.1 321 1st SL
 9T 14.2 538 2nd SL
 13MR 394.1
 Deu 19:15
 Job 33:14
 8MR 413.2
 Isaiah 46:
 Isaiah 1:1 (4 kings)
 Exodus 20:5 (4 generations)
 Joel 1:3 (4 generations)
 Joel 1:4 (4 insects)
 Dan. 9:24-26
 Gal 4:25, 26
 Isa 6:13
 Matthew 24:15

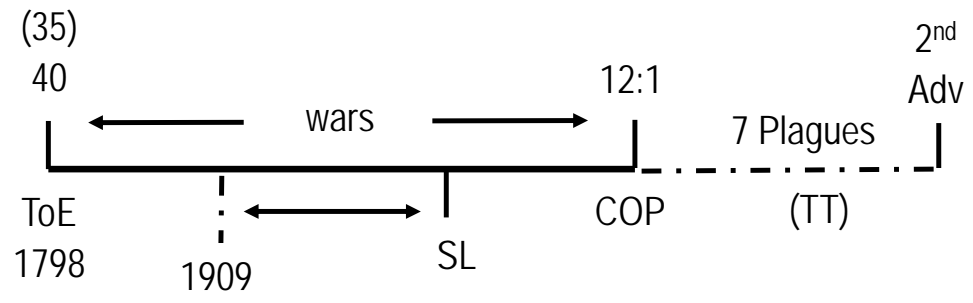

I received a couple of questions; the first question is what is our position regarding ecumenism? So the first thing I thought that might be useful, normally I would ask, it seems to be a rather unusual question or wonder why somebody would ask that question. Let me give you a dictionary definition of what ecumenism means.

The doctrine of The Ecumenical Movement promotes cooperation and a better understanding among different religious denominations. And its aim is to have universal Christian unity

I'll give another definition:
 The term ecumenism refers to efforts by Christians of different denominations as they try to come together and work together.

9T 11.1 321 1st SL
 9T 14.2 538 2nd SL
 13MR 394.1
 Deu 19:15
 Job 33:14
 8MR 413.2
 Isaiah 46:
 Isaiah 1:1 (4 kings)
 Exodus 20:5 (4 generations)
 Joel 1:3 (4 generations)
 Joel 1:4 (4 insects)
 Dan. 9:24-26
 Gal 4:25, 26
 Isa 6:13
 Matthew 24:15

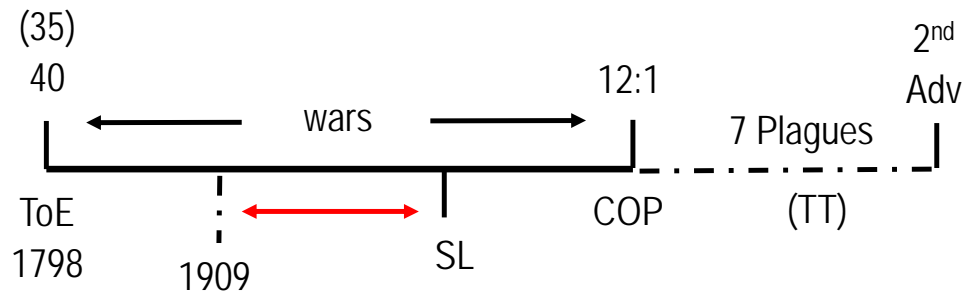

I want to read a Spirit of Prophecy quote taken from the book Darkness Before Dawn page 32. The subject of this chapter is the impending conflict and if you go through the context of what this chapter is about, the impending conflict is the Sunday law. So contextually this passage is being written for God's people who are living in **this dispensation**, before the Sunday law.

In Ellen White's day, I'm not sure how familiar we are with the reform movement, but medicine and science was only beginning to catch up with God's health laws. The Adventist Church were prominent promoters of the health reform message, whether it was smoking, or alcohol, or the general understanding of what we should and should not be eating. Connected to this work of reform there was also a drive for a reform in the dress of people, particularly women's dress. The problem in that dispensation is that the dress of women was damaging their health. There was a drive both in the church and in the world to try and correct these misconceptions or defects in both the way we eat and the way we would dress. Many of these people who were advocating reform were nonreligious people, they may have been atheist and they were not promoting their religion.

9T 11.1 **321 1st SL**
 9T 14.2 **538 2nd SL**
13MR 394.1
 Deu 19:15
 Job 33:14
 8MR 413.2
 Isaiah 46:
 Isaiah 1:1 (4 kings)
 Exodus 20:5 (4 generations)
 Joel 1:3 (4 generations)
 Joel 1:4 (4 insects)
 Dan. 9:24-26
 Gal 4:25, 26
 Isa 6:13
 Matthew 24:15

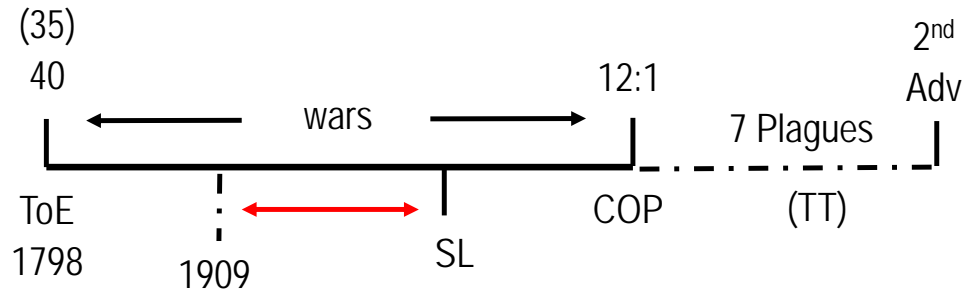

Such cases Ellen White says, in fact she counsels that we could stand shoulder to shoulder with these people. If you want to use this word in a loose sense, not in the sense that we just read, we could enter into a ecumenical relationship with these reform movement people, because they were focused on health, which is something that's dear to the heart of Adventists. However, there were other Christians who wanted to gather support to themselves even though, I don't think they were conscious of what they were doing, they were essentially copying Adventists. I'm sure we're all aware that the health message is the entering wedge of the Third Angel or Ellen White might say it's the right arm of the Gospel. There were some Evangelical Christians who recognized the value of the reform movement, incorporated their ideas into their churches and began to use those reform concepts as an entering wedge to promote their denomination.

9T 11.1	321 1 st SL
9T 14.2	538 2 nd SL
13MR 394.1	
Deu 19:15	
Job 33:14	
8MR 413.2	
Isaiah 46:	
Isaiah 1:1 (4 kings)	
Exodus 20:5 (4 generations)	
Joel 1:3 (4 generations)	
Joel 1:4 (4 insects)	
Dan. 9:24-26	
Gal 4:25, 26	
Isa 6:13	
Matthew 24:15	

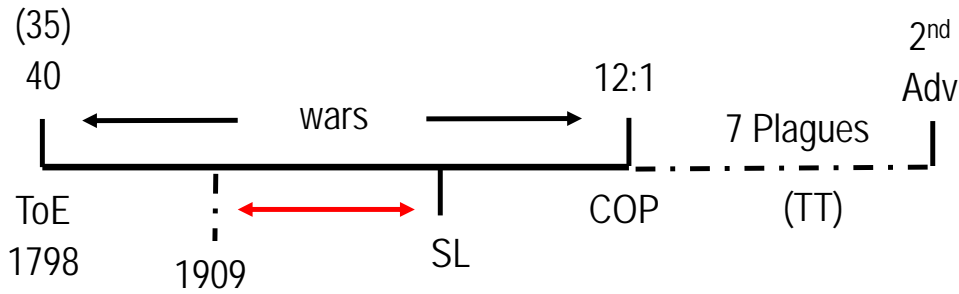

I'll summarize, there are three groups, there are Adventists, there's Protestant Christians and there's just health reformers. Ellen White says we could work with those health reformers. But let's see what she says about those Christian denominations who are promoting a health message that we would all agree with, and let's see what her counsel is about entering into an ecumenical relationship with them.

I'm just going to paraphrase most of this, *the temperance work, one of the most prominent important of moral reforms is often combined with the Sunday movement. And the advocates of the Sunday law movement, they represent themselves as trying to promote the highest interest of society. And those who refuse to unite with these Christians, they're denounced as the enemies of temperance.*

9T 11.1 321 1st SL
 9T 14.2 538 2nd SL
 13MR 394.1
 Deu 19:15
 Job 33:14
 8MR 413.2
 Isaiah 46:
 Isaiah 1:1 (4 kings)
 Exodus 20:5 (4 generations)
 Joel 1:3 (4 generations)
 Joel 1:4 (4 insects)
 Dan. 9:24-26
 Gal 4:25, 26
 Isa 6:13
 Matthew 24:15

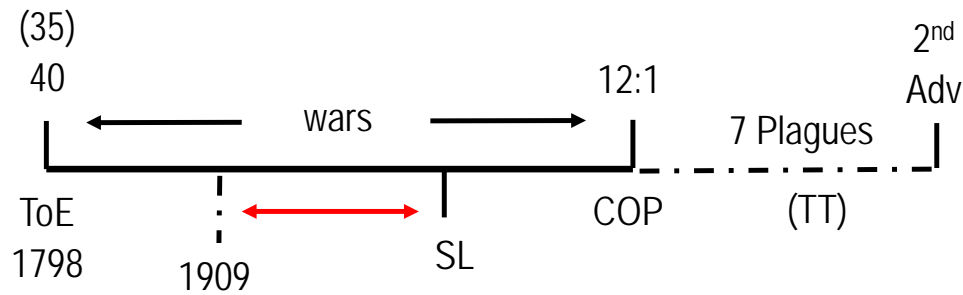

So you can see how these Sunday keepers who are trying to promote their theology are taking the temperance work, combining it with the Sunday movement and they're saying if you don't join us then you're not interested in the temperance work. You're an enemy of reforms.

I want us to understand, when this term temperance movement is spoken of, it's not talking about people like you and me who maybe want to give up some dietary food or stop smoking. This is about government legislation, or we might call the government banning the sale of alcohol. That's what this temperance movement was pushing for.

So these Christians who want to promote their religion connects the temperance movement with their Sunday movement because what's behind their strategy? They're not worried really about the temperance work; their goal is to promote Sunday through legislation.

9T 11.1 321 1st SL
 9T 14.2 538 2nd SL
 13MR 394.1
 Deu 19:15
 Job 33:14
 8MR 413.2
 Isaiah 46:
 Isaiah 1:1 (4 kings)
 Exodus 20:5 (4 generations)
 Joel 1:3 (4 generations)
 Joel 1:4 (4 insects)
 Dan. 9:24-26
 Gal 4:25, 26
 Isa 6:13
 Matthew 24:15, 16
 Joel 1:2
 2 Kings 18:9-12
 Amos 1:1
 Hos 1:1

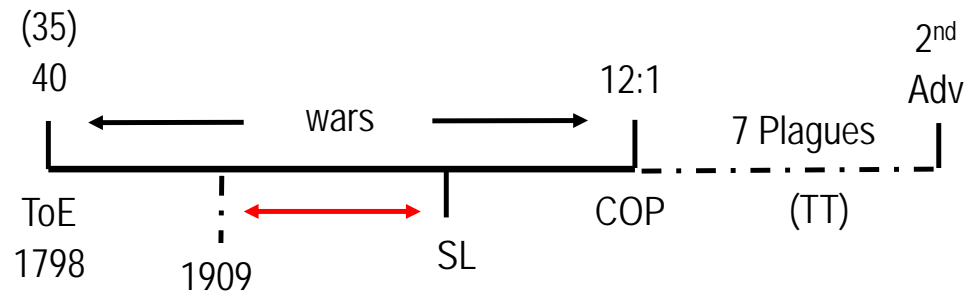

But the fact that a movement to establish error, Sunday, is connected with the work which is good, the temperance, is not an argument in favor of the error. Listen to her argument, we made disguise poison by mixing it with good food but it doesn't change the poison. On the contrary, it makes it more dangerous because you don't know you're even taking the poison. It is one of Satan's devices to combine with falsehood just enough truth to make it believable. The leaders of the Sunday movement, they may advocate reforms that the people need, they may advocate principles that agree with the Bible. But, while they do all of these, if there's a requirement which is contrary to God's law, his servants cannot unite with them, nothing can justify them in setting aside the commandments of God for the precepts of men.

9T 11.1 321 1st SL
 9T 14.2 538 2nd SL
 13MR 394.1
 Deu 19:15
 Job 33:14
 8MR 413.2
 Isaiah 46:
 Isaiah 1:1 (4 kings)
 Exodus 20:5 (4 generations)
 Joel 1:3 (4 generations)
 Joel 1:4 (4 insects)
 Dan. 9:24-26
 Gal 4:25, 26
 Isa 6:13
 Matthew 24:15, 16
 Joel 1:2
 2 Kings 18:9-12
 Amos 1:1
 Hos 1:1

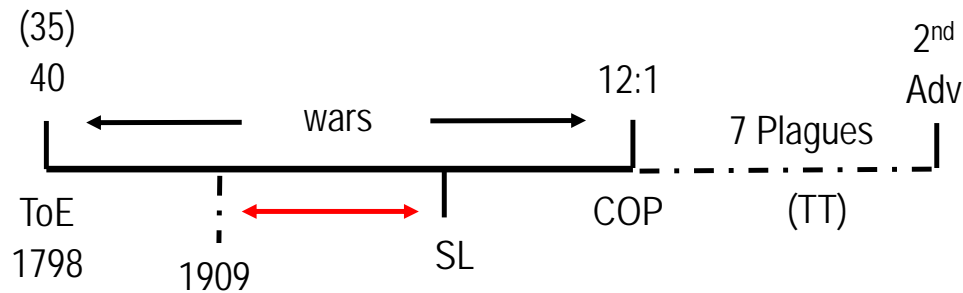

Today, the temperance movement, it's not about alcohol. It's about how much water we use, how much electricity we consume. Some people call it the green movement. It's taking care of our world and we already know who is one of the greatest promoters of this temperance work today, where they want countries from the West to not live in excess at the expense of the poor third world countries. We know who that body of people are, the Catholic Church are the foremost promoters of this. And if you see what they're promoting it may well be in agreement with Biblical principles, we want to take care of nature, we don't want to waste natural resources. But what we cannot do is stand shoulder to shoulder with these people in an ecumenical relationship based on common values that we share with them.

So it's our understanding that we should not enter into ecumenical relationships with other organizations, in agreement with Ellen White.

9T 11.1 321 1st SL
 9T 14.2 538 2nd SL
 13MR 394.1
 Deu 19:15
 Job 33:14
 8MR 413.2
 Isaiah 46:
 Isaiah 1:1 (4 kings)
Exodus 20:5 (4 generations)
Joel 1:3 (4 generations)
Joel 1:4 (4 insects)
 Dan. 9:24-26
 Gal 4:25, 26
 Isa 6:13
 Matthew 24:15, 16
 Joel 1:2
 2 Kings 18:9-12
 Amos 1:1
 Hos 1:1

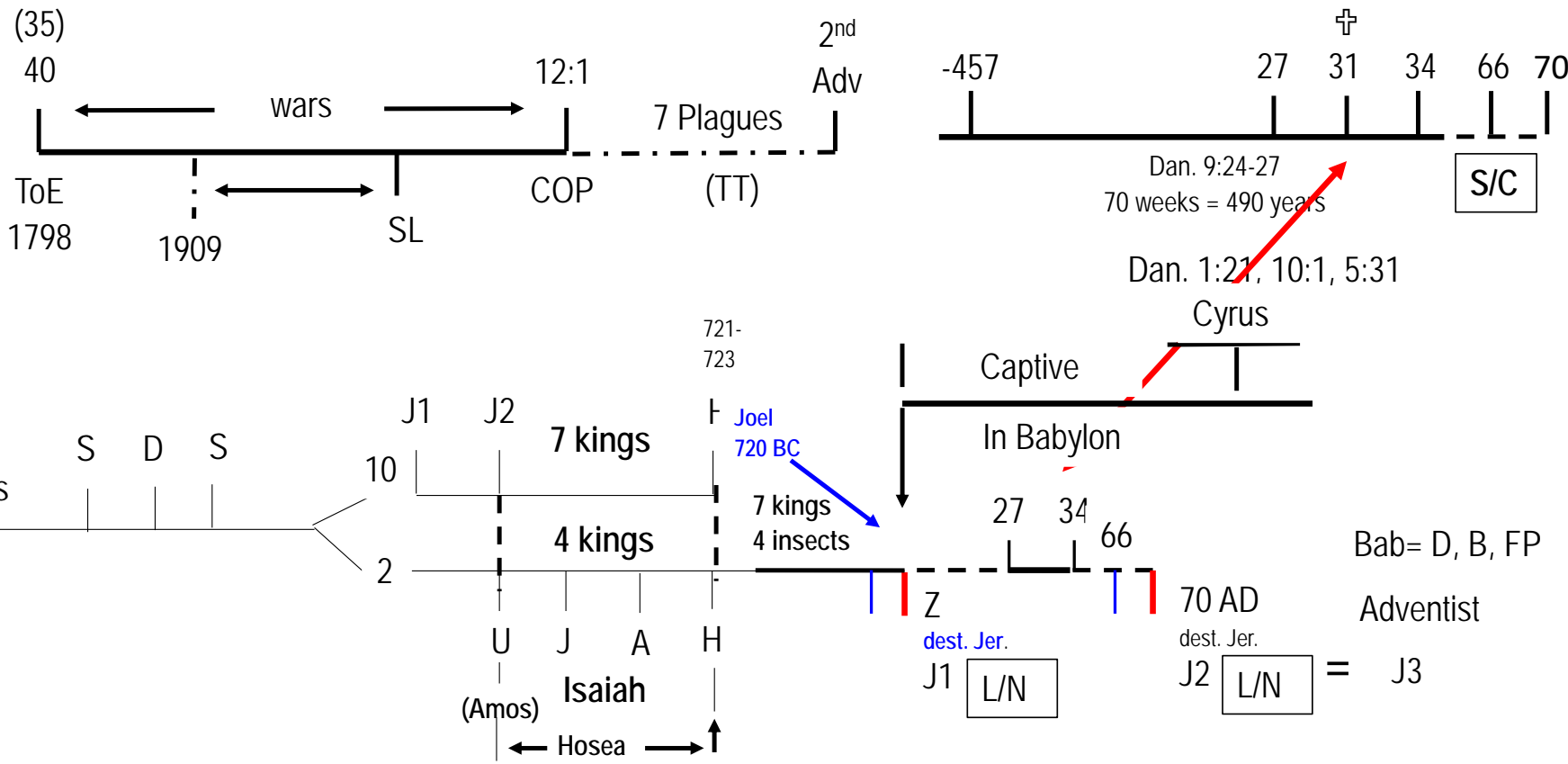

Another example of this, an Old Testament story, we mentioned Saul, David and Solomon, when Solomon becomes king before he has a dream and commits allegiance to God, seeking for wisdom and understanding to lead His people, and God blesses him, before that, he's already broken his allegiance to God. The record is clear that he enters into affinity with Pharaoh. He marries Pharaoh's daughter. We'll go to first Kings 3:1 *And Solomon made affinity with Pharaoh king of Egypt, and took Pharaoh's daughter, and brought her into the city of David, until he had made an end of building his own house, and the house of the LORD, and the wall of Jerusalem round about.*

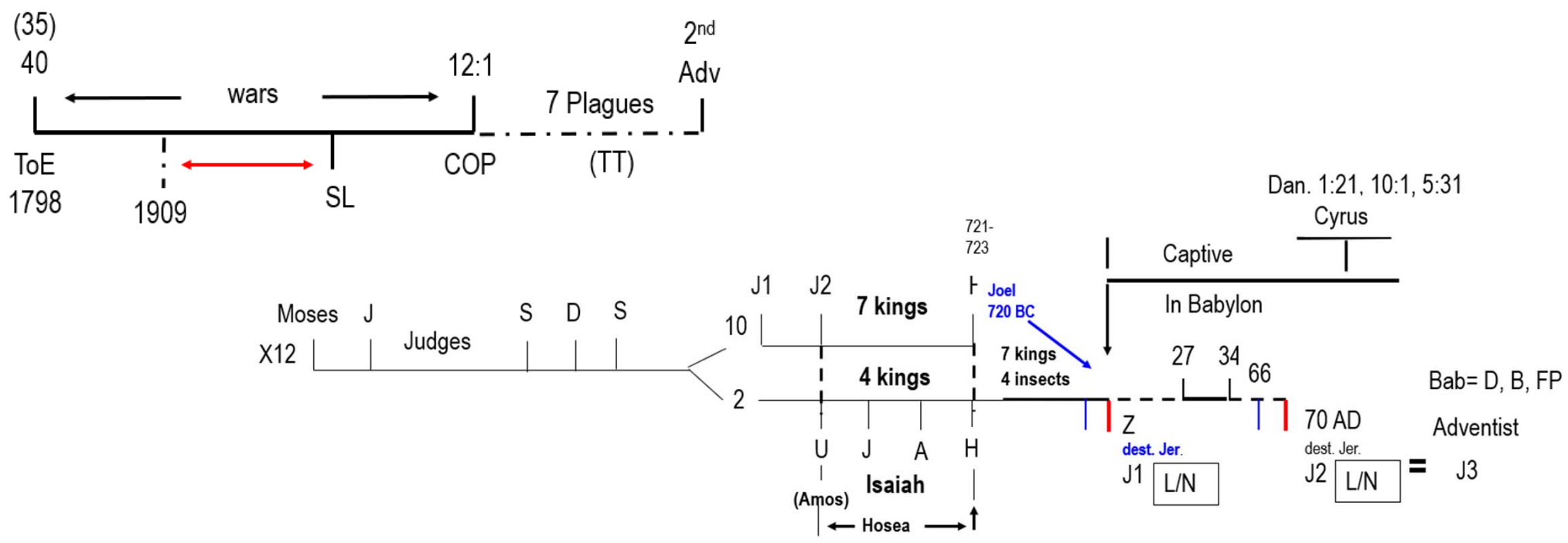

It tells us that Solomon went into an affinity, which means a binding agreement with Egypt. And to seal the deal he takes Pharaoh's daughter; he's not allowed to marry a foreign woman and it was never God's will that God's people should go into affinity with the nations. There are Old Testament examples and the example that I just gave in the Spirit of Prophecy.

Ahab, one of these kings here in the northern tribes, he marries Jezebel because he goes into affinity with that nation. All of these examples are examples of ecumenical relationships. That's why we don't advocate this policy.

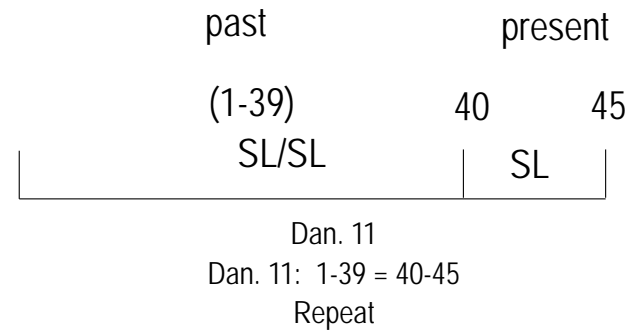
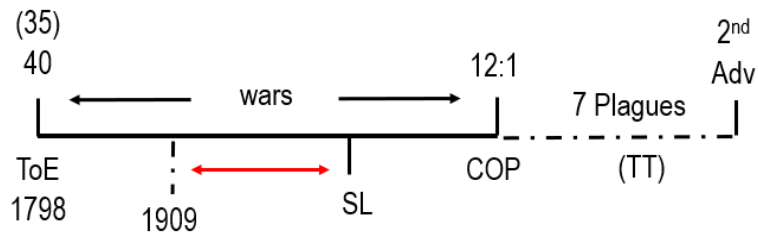

- 9T 11.1 321 1st SL
- 9T 14.2 538 2nd SL
- 13MR 394.1
- Deu 19:15
- Job 33:14
- 8MR 413.2
- Isaiah 46:
- Isaiah 1:1 (4 kings)
- Exodus 20:5 (4 generations)
- Joel 1:3 (4 generations)
- Joel 1:4 (4 insects)
- Dan. 9:24-26
- Gal 4:25, 26
- Isa 6:13
- Matthew 24:15

There was a second question, the methodology that I'm speaking about, which is connected to parable teaching, which takes the natural, the world in which we live to explain the spiritual, can be understood on a number of different levels or layers. So we can consider the natural to the spiritual. Another way to understand that is **to go from the past to the present**. Yesterday we spoke about juxta positioning. This person, how do you know how tall they are? So if I said or ask is this person tall or short, you have no way of knowing. What you have to do is create a parable, we have a limited understanding of parables. Because generally as a people, we haven't been careful in the study of inspiration to see how extensively they're used. So if you get the model of repeat and enlarge, which means you say something twice, and the second time you say it you use a different example or a different language, that's nothing more than parables. We might call it compare and contrast. There are different ways to explain this phenomena. To explain it clearly, we'd have to go into the definition of the word, into the Greek and explore the Spirit of Prophecy and how it's used.

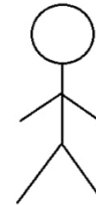

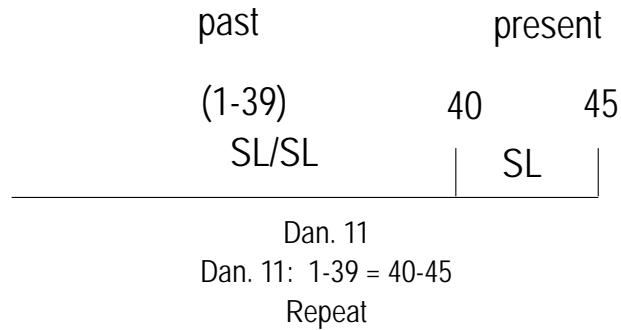
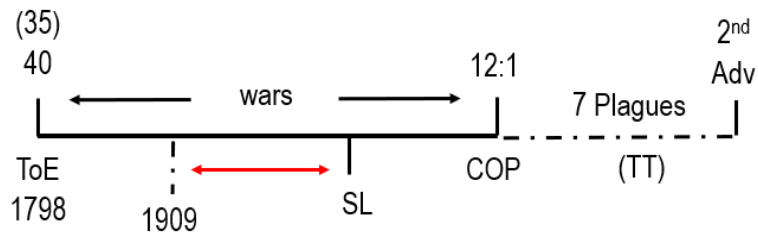

- 9T 11.1 321 1st SL
- 9T 14.2 538 2nd SL
- 13MR 394.1
- Deu 19:15
- Job 33:14
- 8MR 413.2
- Isaiah 46:
- Isaiah 1:1 (4 kings)
- Exodus 20:5 (4 generations)
- Joel 1:3 (4 generations)
- Joel 1:4 (4 insects)
- Dan. 9:24-26
- Gal 4:25, 26
- Isa 6:13
- Matthew 24:15

I gave an example, to know if this person is big or short, I have to put them next to something, so here's a mountain and I took a picture. Is the person big or small? You don't know, in fact you do know because we know that there's no human being that's bigger than a mountain. So you know what I've done, I've taken a picture where this person is 5 km in front of this mountain. The reason we know that is because we live in the natural literal world and we have a concept, an image of how this world operates. So automatically you would never be tricked by that, by my optical illusion. Now if I really turn that into a parable the man would look like this in real life. Then we would know that he is minute compared to a mountain. The problem we face is that we are not familiar with the spiritual realm. From the fall of Adam, when God stop communicating with us face to face the only means by which we can communicate with Him separate to dreams and visions that he gives to His prophets is through parables. It's written or whether it's natural, they are the two major books that God has given us, the Bible, His word and the Book of Nature, the world we live in. That includes our family relationship.

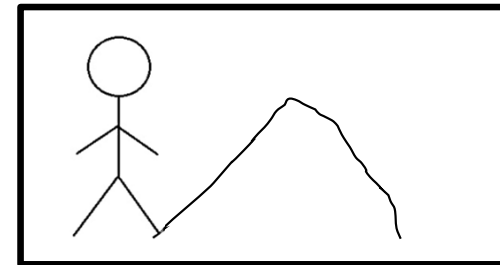

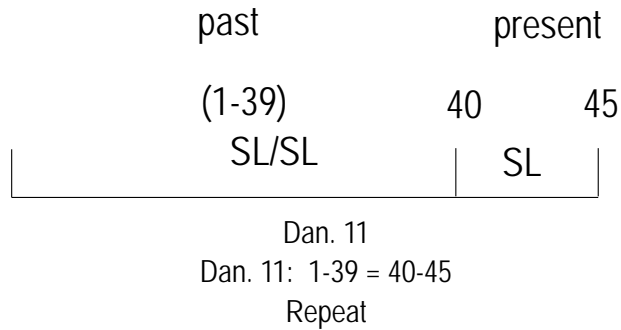
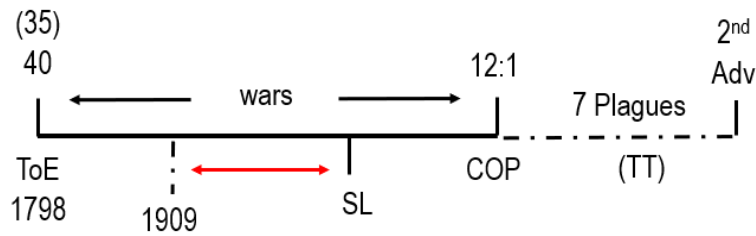

- 9T 11.1 321 1st SL
- 9T 14.2 538 2nd SL
- 13MR 394.1
- Deu 19:15
- Job 33:14
- 8MR 413.2
- Isaiah 46:
- Isaiah 1:1 (4 kings)
- Exodus 20:5 (4 generations)
- Joel 1:3 (4 generations)
- Joel 1:4 (4 insects)
- Dan. 9:24-26
- Gal 4:25, 26
- Isa 6:13
- Matthew 24:15

The question that was asked, is if we are going to talk about parables and we're going to talk about history repeating, is this emphasis on repeating history too strong? I'll read the question, *the methodology that states the past is the same as the present, am I not exaggerating this too much? Is it clearly supported in the Bible and also if it is why has the Adventist Church not become so familiar with it?*

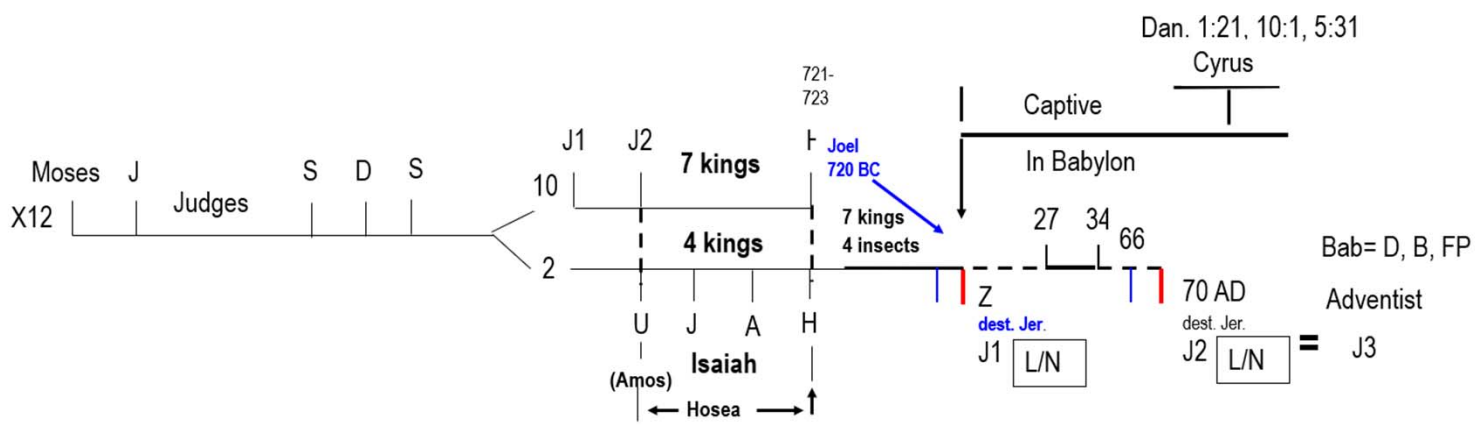
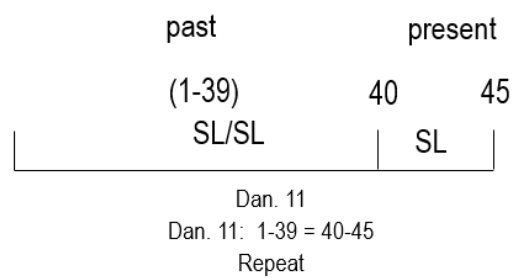
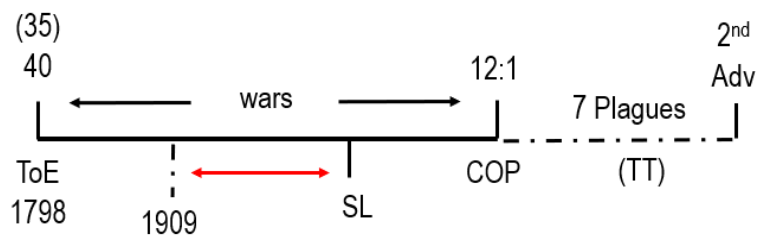

- 9T 11.1 321 1st SL
- 9T 14.2 538 2nd SL
- 13MR 394.1
- Deu 19:15
- Job 33:14
- 8MR 413.2
- Isaiah 46:
- Isaiah 1:1 (4 kings)
- Exodus 20:5 (4 generations)
- Joel 1:3 (4 generations)
- Joel 1:4 (4 insects)
- Dan. 9:24-26
- Gal 4:25, 26
- Isa 6:13
- Matthew 24:15

When it comes to clear biblical evidence it's my understanding that the models that I've shared with you of these Sunday laws, these remnants, the destruction of Jerusalem, we haven't completed or fully discussed the modeling of seven and four, but all of these histories, all of them show clearly that history is repeating. Ellen White is absolutely clear, there are pages after pages where she talks about this concept of history repeating. I'm just going to read a few of them to show you how frequently she talks about this issue.

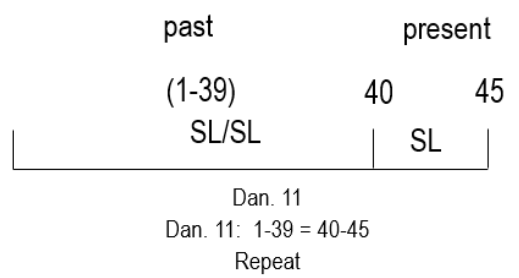
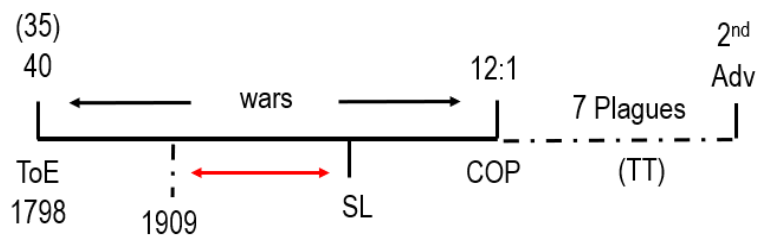

- 9T 11.1 321 1st SL
- 9T 14.2 538 2nd SL
- 13MR 394.1
- Deu 19:15
- Job 33:14
- 8MR 413.2
- Isaiah 46:
- Isaiah 1:1 (4 kings)
- Exodus 20:5 (4 generations)
- Joel 1:3 (4 generations)
- Joel 1:4 (4 insects)
- Dan. 9:24-26
- Gal 4:25, 26
- Isa 6:13
- Matthew 24:15

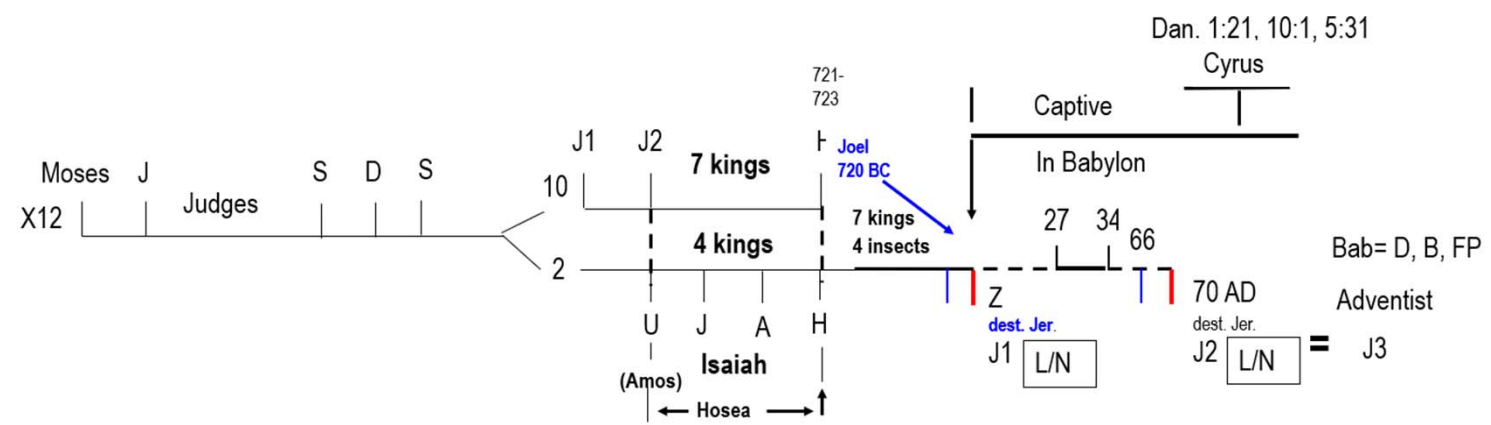

We'll go to two passages first, to Ecclesiastes 1:9, 10

1:9 *The thing that hath been, it [is that] which shall be; and that which is done [is] that which shall be done: and [there is] no new [thing] under the sun.*

1:10 *Is there [any] thing whereof it may be said, See, this [is] new? it hath been already of old time, which was before us.*

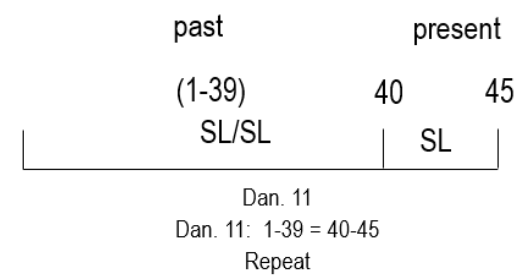
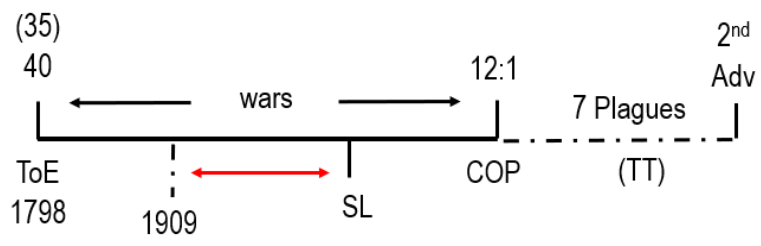

- 9T 11.1 321 1st SL
- 9T 14.2 538 2nd SL
- 13MR 394.1
- Deu 19:15
- Job 33:14
- 8MR 413.2
- Isaiah 46:
- Isaiah 1:1 (4 kings)
- Exodus 20:5 (4 generations)
- Joel 1:3 (4 generations)
- Joel 1:4 (4 insects)
- Dan. 9:24-26
- Gal 4:25, 26
- Isa 6:13
- Matthew 24:15

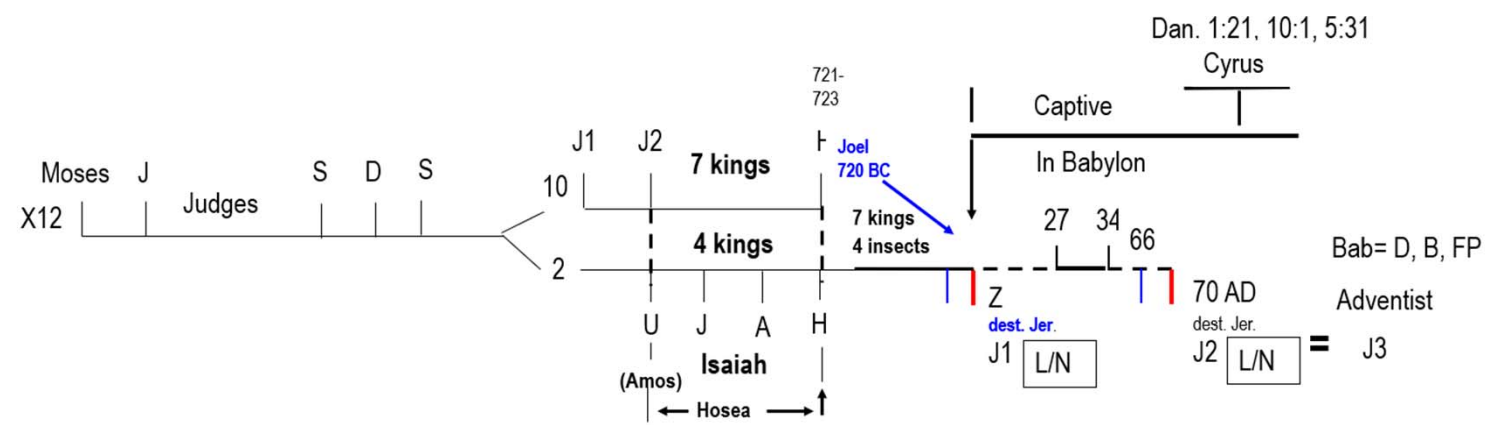

Verse 9 clearly tells you that the things that have already happened are the same as the ones that are going to come in the future. And the things which have been done in the past are the same as those that are going to be done in the future because there's nothing new under the sun. So everything connected with end time prophecy, in some shape or form, in it's natural and literal phenomena, has already happened in the past. All we need to do is understand the past well, for when those things become a present fulfillment, what we would call the spiritual, or the present we should be able to identify the things that are going on.

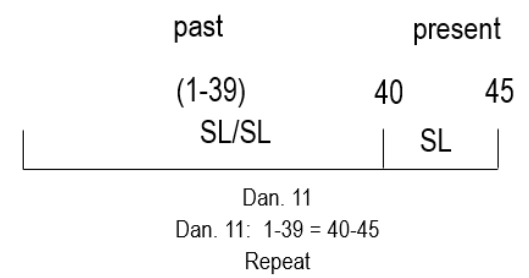
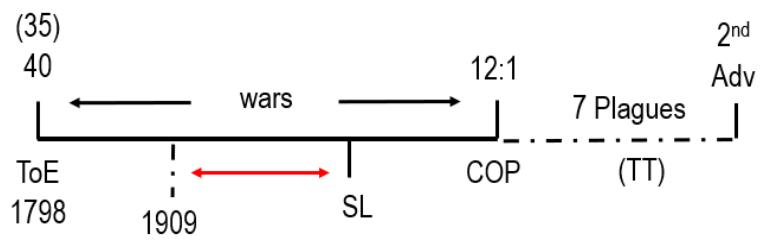

- 9T 11.1 321 1st SL
- 9T 14.2 538 2nd SL
- 13MR 394.1
- Deu 19:15
- Job 33:14
- 8MR 413.2
- Isaiah 46:
- Isaiah 1:1 (4 kings)
- Exodus 20:5 (4 generations)
- Joel 1:3 (4 generations)
- Joel 1:4 (4 insects)
- Dan. 9:24-26
- Gal 4:25, 26
- Isa 6:13
- Matthew 24:15

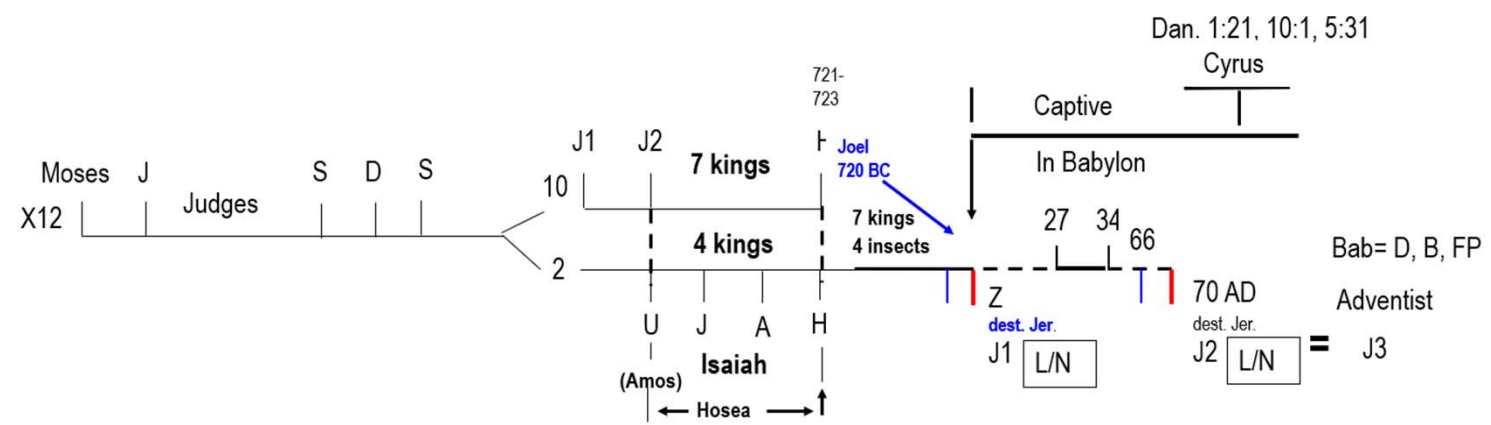

What we cannot do is go back into the past and take Jerusalem, the literal city and do what Evangelical Christians do, support and protect Jerusalem here at the end of the world in the present. Because they believe that that Jerusalem is the same as this Jerusalem at the end of the world. It's not. So even though history repeats, it's repetition here at the end of the world cannot be understood in its local literal sense. We saw in Revelation 17 and 18 that Babylon is not a city in Iraq. It's a worldwide movement that is in opposition to God.

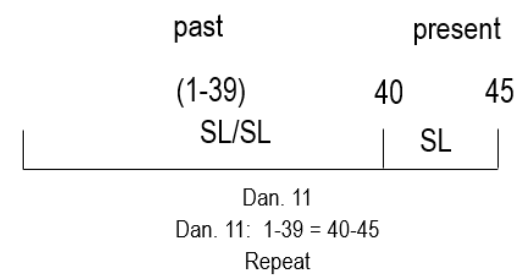
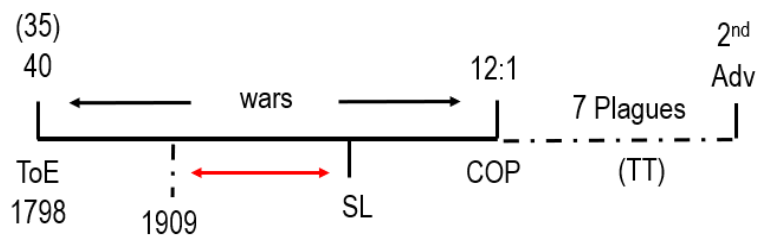

- 9T 11.1 321 1st SL
- 9T 14.2 538 2nd SL
- 13MR 394.1
- Deu 19:15
- Job 33:14
- 8MR 413.2
- Isaiah 46:
- Isaiah 1:1 (4 kings)
- Exodus 20:5 (4 generations)
- Joel 1:3 (4 generations)
- Joel 1:4 (4 insects)
- Dan. 9:24-26
- Gal 4:25, 26
- Isa 6:13
- Matthew 24:15

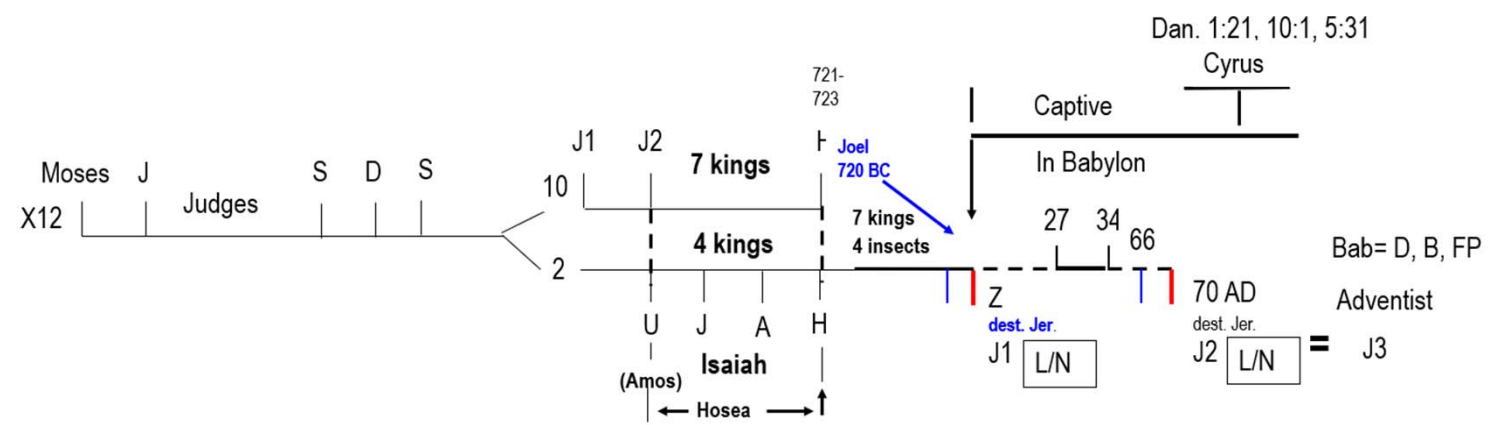

Even though the symbology is the same, Revelation 16:12, two kings from the East will come dry up the river Euphrates and destroy Babylon. That's an end time fulfillment which is identical to what Cyrus and Darius did. The Bible teaches that it's identical. But what we have to do is decipher the code to see what the fulfillment looks like at the end of the world, to understand who the kings are, what does it mean if they come from the East, and who Babylon is.

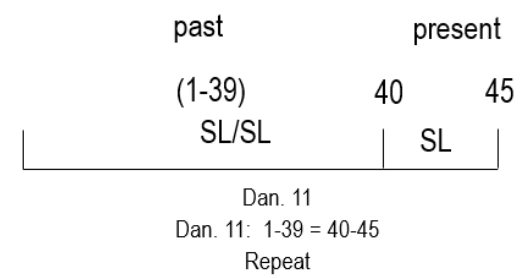
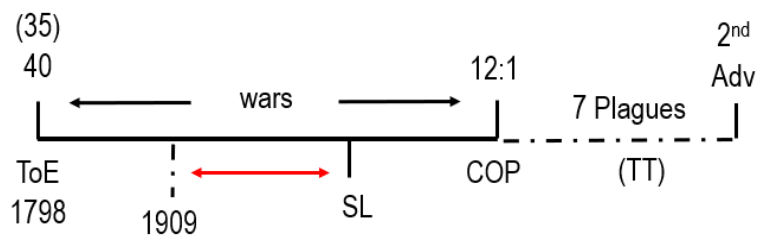

- 9T 11.1 321 1st SL
- 9T 14.2 538 2nd SL
- 13MR 394.1
- Deu 19:15
- Job 33:14
- 8MR 413.2
- Isaiah 46:
- Isaiah 1:1 (4 kings)
- Exodus 20:5 (4 generations)
- Joel 1:3 (4 generations)
- Joel 1:4 (4 insects)
- Dan. 9:24-26
- Gal 4:25, 26
- Isa 6:13
- Matthew 24:15, 16
- Joel 1:2
- 2 Kings 18:9-12
- Amos 1:1
- Hos 1:1

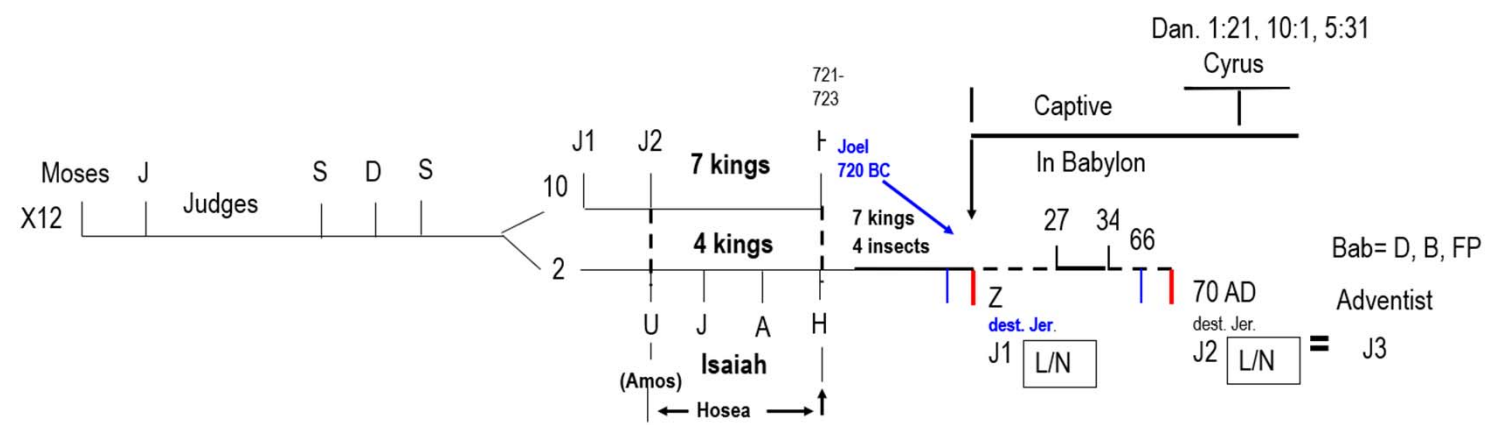

I'll give you one example of how you do that without going into detail. There are these kings that are rising from the East, that's Revelation 16 verse 12, and they're going to come and destroy Babylon. What supports Babylon, what protected Babylon in the original history? It was the river Euphrates. The river Euphrates made it impregnable because it had a constant water supply. What do they do? They dry up the river Euphrates and they destroyed the city.

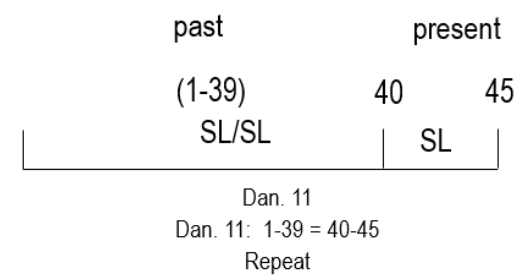
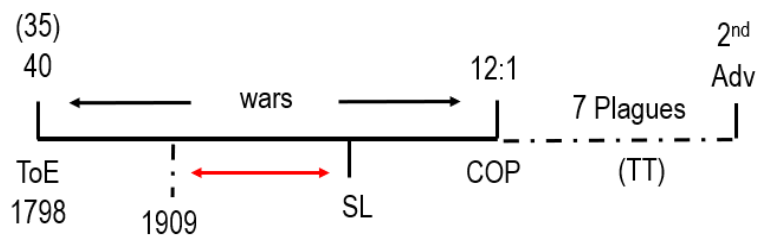

- 9T 11.1 321 1st SL
- 9T 14.2 538 2nd SL
- 13MR 394.1
- Deu 19:15
- Job 33:14
- 8MR 413.2
- Isaiah 46:
- Isaiah 1:1 (4 kings)
- Exodus 20:5 (4 generations)
- Joel 1:3 (4 generations)
- Joel 1:4 (4 insects)
- Dan. 9:24-26
- Gal 4:25, 26
- Isa 6:13
- Matthew 24:15, 16
- Joel 1:2
- 2 Kings 18:9-12
- Amos 1:1
- Hos 1:1

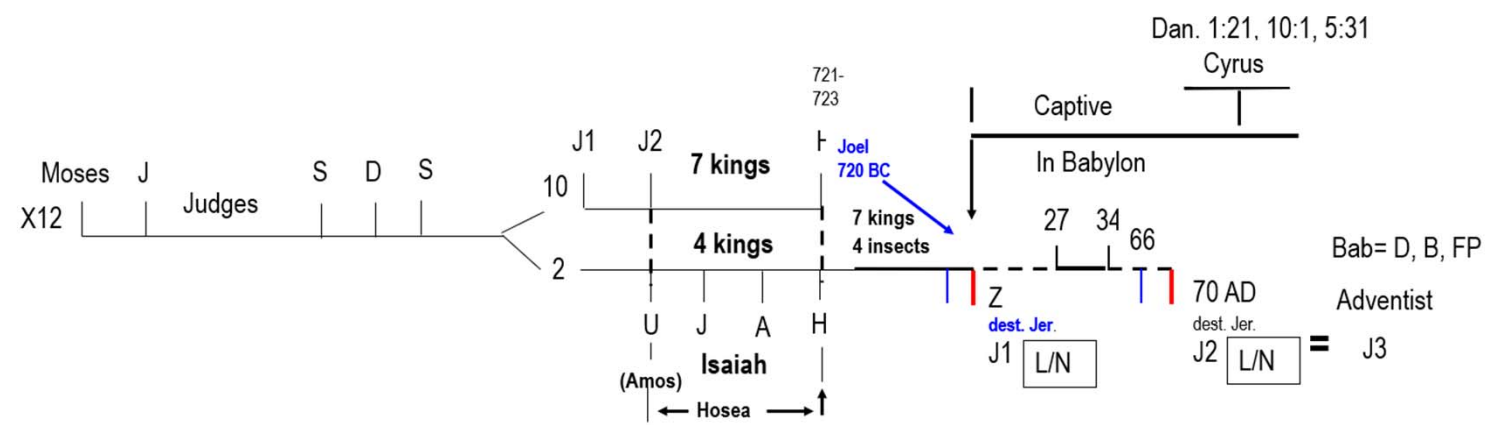

Now the river Euphrates is a river, it's water and what do waters represent at the end of the world? It represents kings, rulers, nations, people, we know that. So if you dry up the support that the kingdoms of this world give to Babylon then Babylon will come to its end. And which king at the end of the world comes from the East? Go to Revelation 7 verse 2.

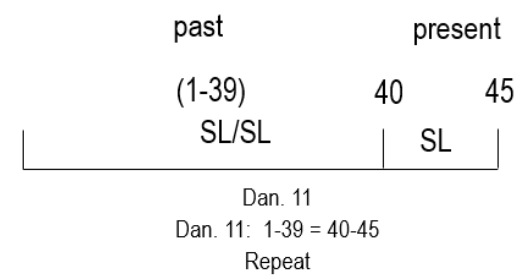
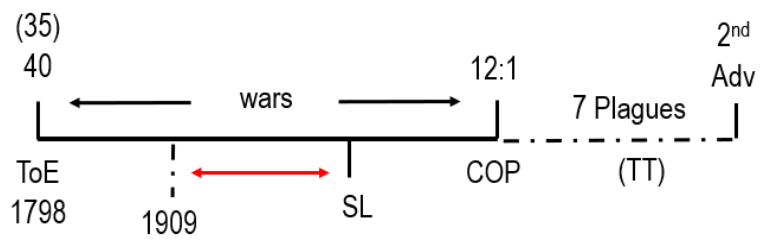

- 9T 11.1 321 1st SL
- 9T 14.2 538 2nd SL
- 13MR 394.1
- Deu 19:15
- Job 33:14
- 8MR 413.2
- Isaiah 46:
- Isaiah 1:1 (4 kings)
- Exodus 20:5 (4 generations)
- Joel 1:3 (4 generations)
- Joel 1:4 (4 insects)
- Dan. 9:24-26
- Gal 4:25, 26
- Isa 6:13
- Matthew 24:15, 16
- Joel 1:2
- 2 Kings 18:9-12
- Amos 1:1
- Hos 1:1

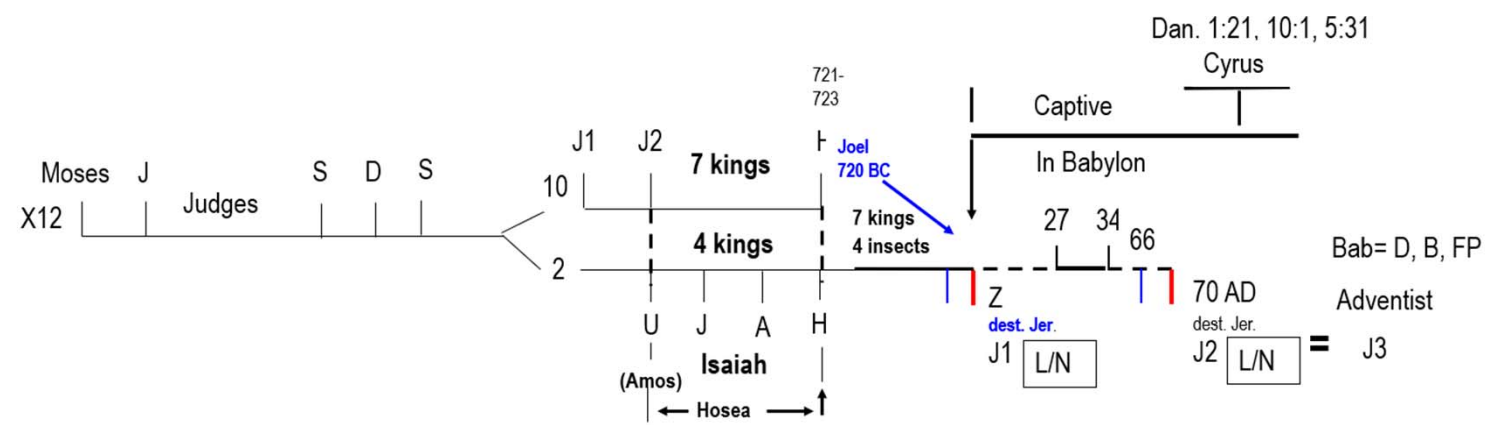

Revelation 7:2 *And I saw another angel ascending from the east, having the seal of the living God: and he cried with a loud voice to the four angels, to whom it was given to hurt the earth and the sea,*

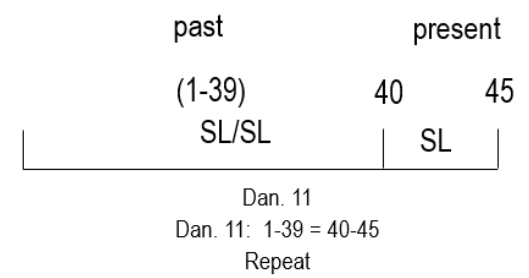
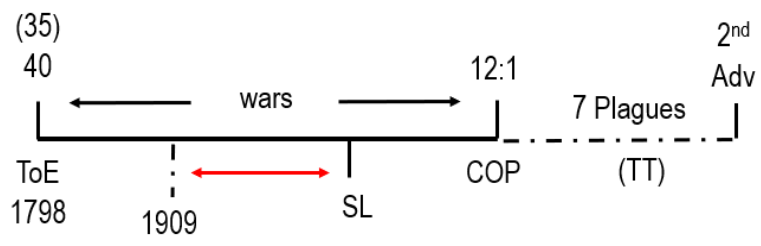

- 9T 11.1 321 1st SL
- 9T 14.2 538 2nd SL
- 13MR 394.1
- Deu 19:15
- Job 33:14
- 8MR 413.2
- Isaiah 46:
- Isaiah 1:1 (4 kings)
- Exodus 20:5 (4 generations)
- Joel 1:3 (4 generations)
- Joel 1:4 (4 insects)
- Dan. 9:24-26
- Gal 4:25, 26
- Isa 6:13
- Matthew 24:15, 16
- Joel 1:2
- 2 Kings 18:9-12
- Amos 1:1
- Hos 1:1

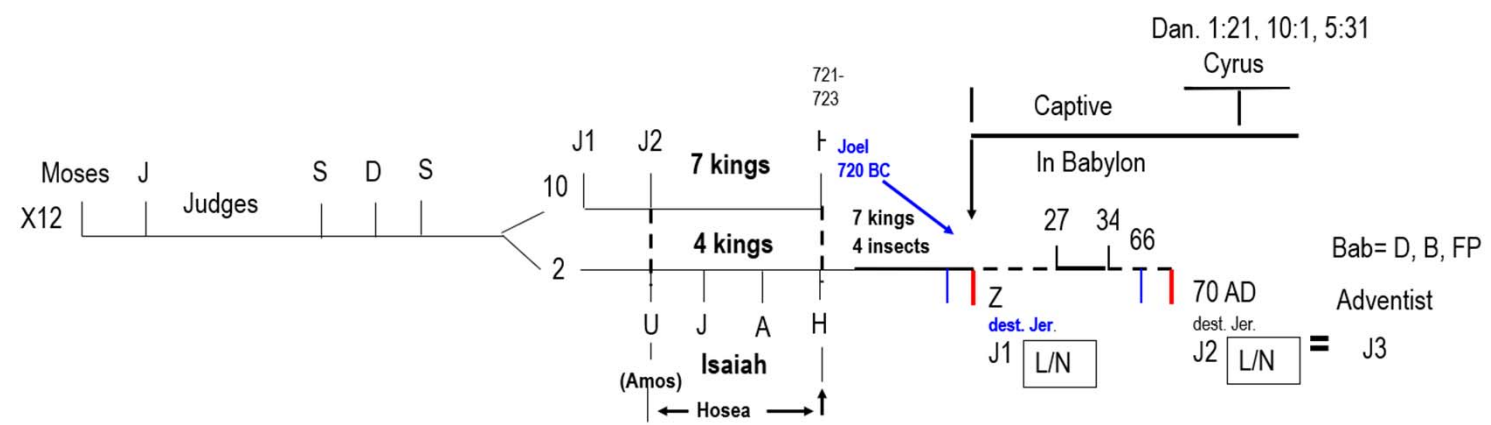

So there's someone that's ascending from the East with a message. We could do a study on the east, but it's from the East that righteousness comes. We know that Jesus is like the sun that rises from the East, so you can begin to see how you would work through this symbology that's given in Revelation 16, but the story is framed as a repeat of history. So that's what I'm teaching when I say history repeats. It's not repeating in this literal fashion that there's literal Babylon and literal Jerusalem or that there's literal Jews.

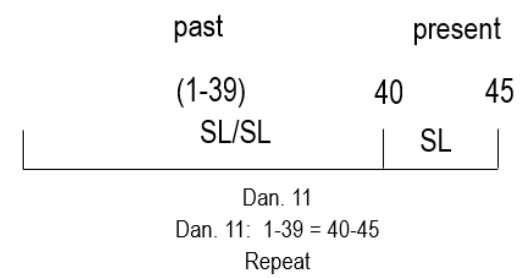
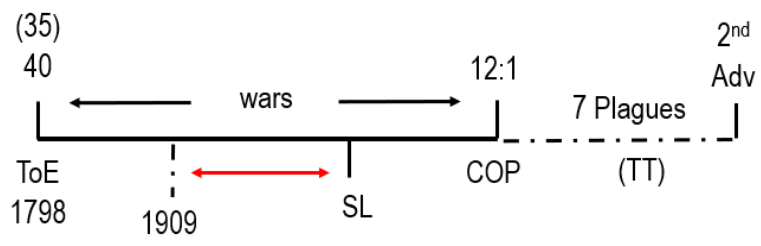

- 9T 11.1 321 1st SL
- 9T 14.2 538 2nd SL
- 13MR 394.1
- Deu 19:15
- Job 33:14
- 8MR 413.2
- Isaiah 46:
- Isaiah 1:1 (4 kings)
- Exodus 20:5 (4 generations)
- Joel 1:3 (4 generations)
- Joel 1:4 (4 insects)
- Dan. 9:24-26
- Gal 4:25, 26
- Isa 6:13
- Matthew 24:15, 16
- Joel 1:2
- 2 Kings 18:9-12
- Amos 1:1
- Hos 1:1

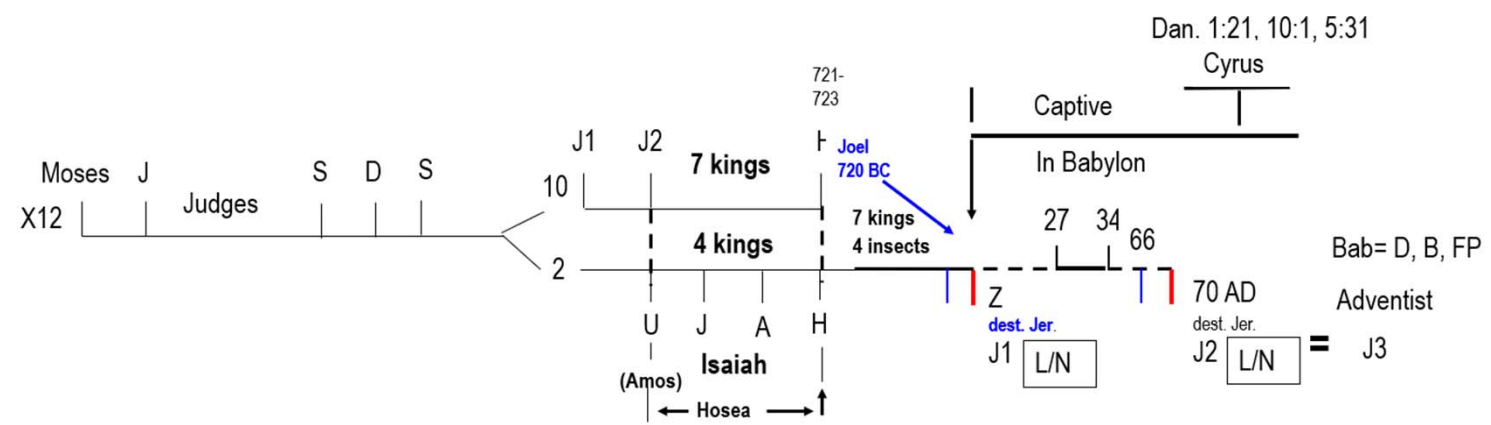

I'm going to go through this fairly rapidly, the first reference is 9 MR Page 275

When history should be repeated, when the great men of earth will not come to the Bible for light, when the commandments of men shall be exalted above the commandments of God, when it will be regarded as a crime to obey God rather than man, then we shall not have to tread a path in which we have had only a few examples. Because we've had many examples of this. The examples that she's speaking of are not just biblical examples, their examples from the Reformation. And in this particular example she's mentioning about John Huss, the famous evangelist. As he was taken prisoner and killed because he would not obey man, she says that history will be repeated.

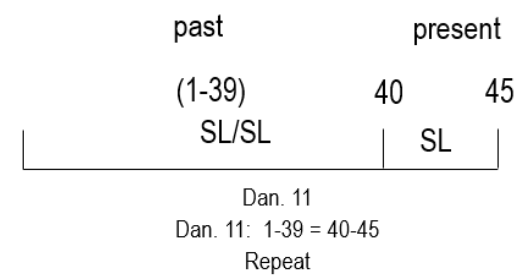
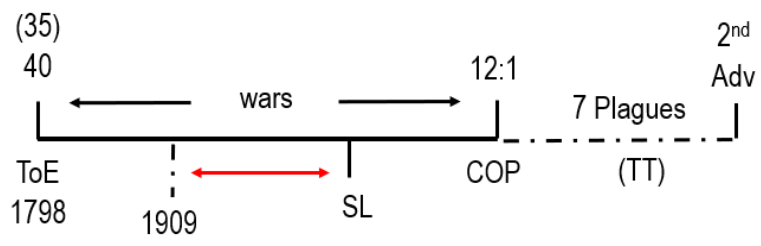

- 9T 11.1 321 1st SL
- 9T 14.2 538 2nd SL
- 13MR 394.1
- Deu 19:15
- Job 33:14
- 8MR 413.2
- Isaiah 46:
- Isaiah 1:1 (4 kings)
- Exodus 20:5 (4 generations)
- Joel 1:3 (4 generations)
- Joel 1:4 (4 insects)
- Dan. 9:24-26
- Gal 4:25, 26
- Isa 6:13
- Matthew 24:15, 16
- Joel 1:2
- 2 Kings 18:9-12
- Amos 1:1
- Hos 1:1

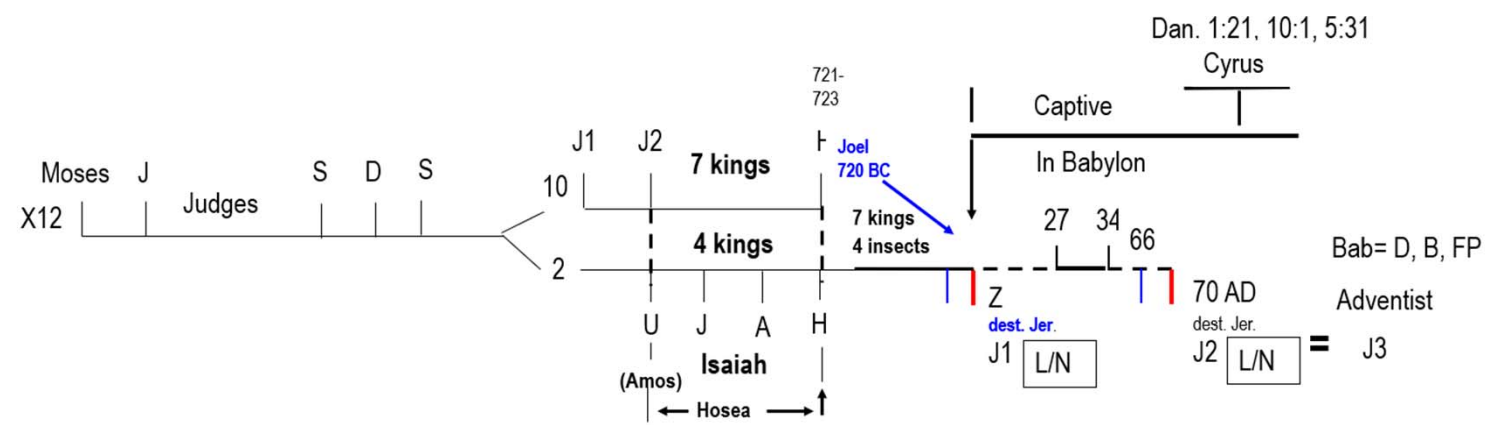

Review and Herald August 19th 1890 paragraph 3

When the Third Angels Message is preached as it should be then power will come. I'm often referred to the parable of the ten virgins, this parable (which is Matthew 25) has been fulfilled and will be fulfilled. Therefore, it will be repeated. She says more, like the Third Angels Message, the parable of the 10 virgins, has been fulfilled and will continue to be present truth. So both the parable of the 10 virgins and the Third Angels Messages have been fulfilled in the past, and their histories, their events will be repeated

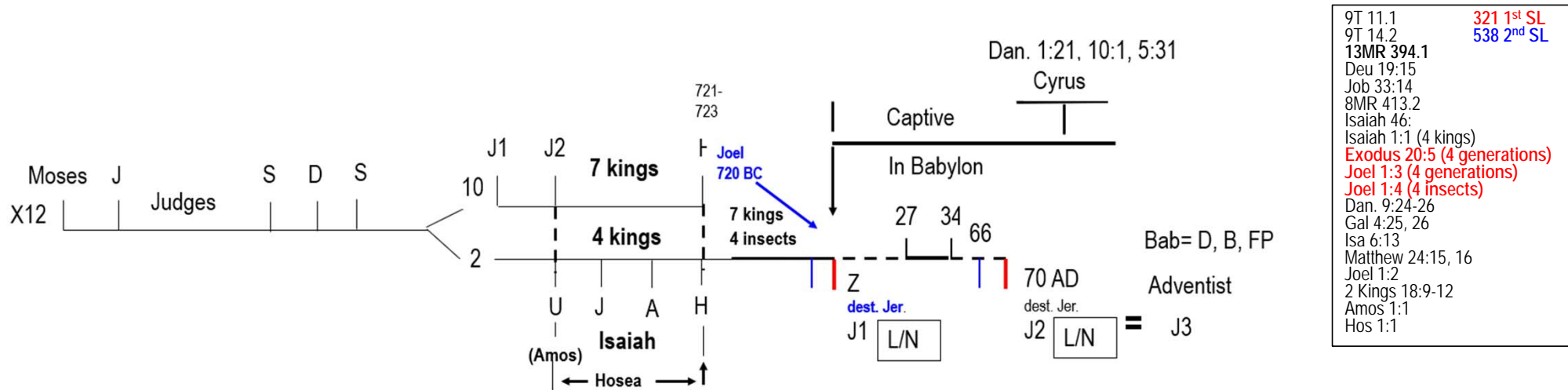

It's our work to understand how the Third Angels Message is going to be repeated at the end of the world because many of God's people don't understand.

Selected messages volume three page 338

Each of the ancient Prophets spoke less for their time then for our time so that their prophesying is in force for us. The story of Ruth, Esther, Balaam, Nehemiah, all of these stories, which were literal stories, they were written for us. How could they benefit us? The question was asked why has the church not picked up and seen this. Let me try to say in a simple way, if we go to the book of Nehemiah, if we go to Ruth or Esther or Ezra, our church will read those stories and will teach and preach about them, extensively. The problem that our church faces that they only look at these stories in a moral framework. They do not see that these stories have encoded in them prophetic information which is teaching us about things at the end of the world.

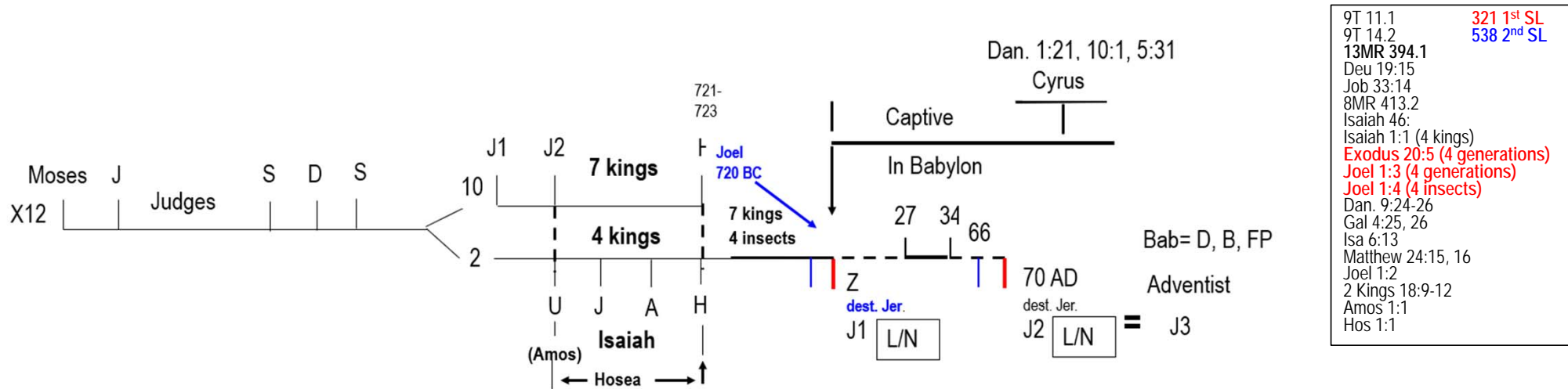

I'll give you one example, a simple one, you've all read the story of Esther; the book of Esther is a love story. Now if you listen to any sermon on that book, every preacher will tell you that Esther was a good woman, that she was righteous and virtuous. But let me ask you a question: did Esther commit adultery? She did, the king Ahasuerus divorces his wife for no good reason. In chapter 2 Esther marries him. Firstly, it's forbidden against the law, so she broke the law because he was a foreigner. On a second count she commits adultery. If you're familiar with the story, her cousin Mordecai, he gets into trouble with the prime minister, why? Because he refuses to bow down to a human being, he would rather die than bow down to a man. Check what Esther does, she bows down to her husband multiple times, she marries a foreigner, she commits adultery, and she bows down to a man. She breaks the law all the time, and if you argue she didn't have a choice, do you have a choice? Of course, everyone has a choice, because she would have forfeited her life. Her cousin was prepared to and it's the same cousin that instructs her to marry this man. He won't sin but he tells his cousin to sin.

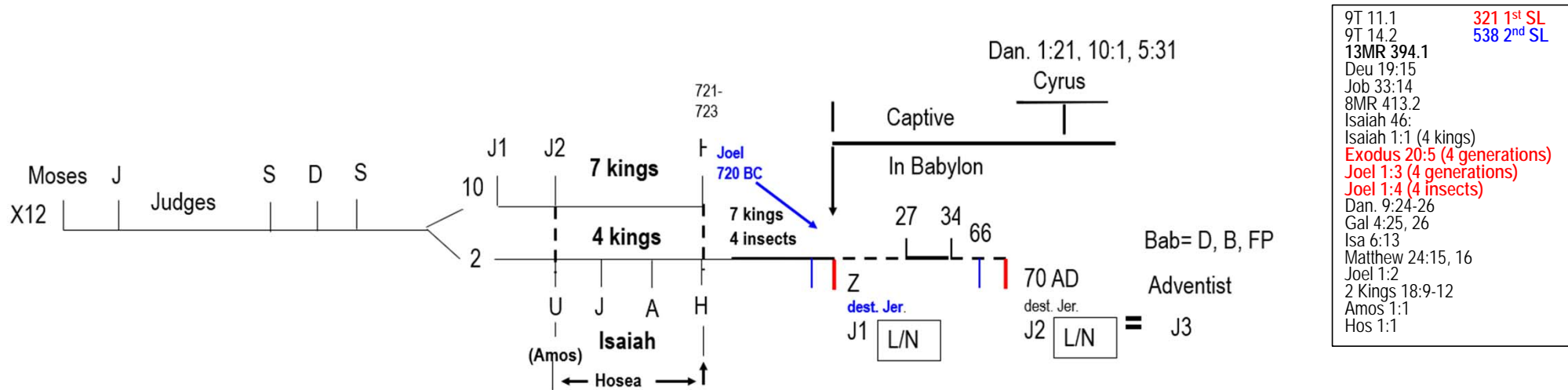

There is a surface, superficial morality to the story. I argue that the Book of Esther is a prophetic story, it's a parable that's teaching us because we know that marriage is a story about God and his people. That Persian King becomes a symbol of Christ who's already married to a woman who disobeys him, he divorces her and marries a new wife. This is Christ separating from the Jewish nation and marrying the Christian church. It's also the story of Christ divorcing Laodicea, the 7th and last Church in Bible prophecy and marrying another church. We might call it the remnant. That's what the Book of Esther is to teach us. About a hundred years ago, just after the death of Ellen White, our theologians began to restructure our prophetic model. The first step was to separate our prophetic message from our moral message. And once you separate the two, it was a slippery road down, where not only we would minimize our prophetic message, but we would lose the ability, or as the question said we would lose our familiarity to properly understand parables in the scriptures at the prophetic level as well as the moral.



Dan. 11
 Dan. 11: 1-39 = 40-45
 Repeat

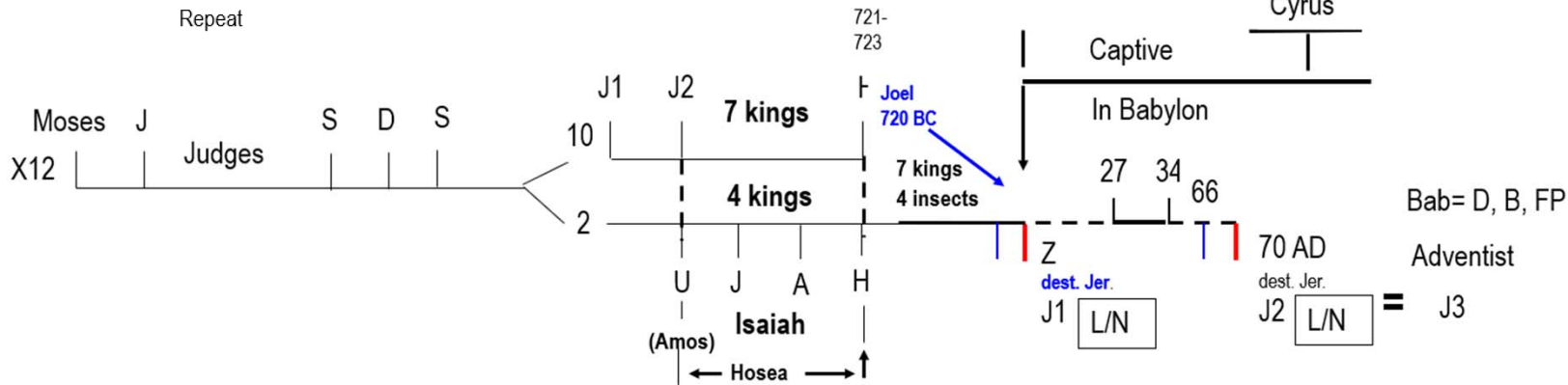

- 9T 11.1 321 1st SL
- 9T 14.2 538 2nd SL
- 13MR 394.1
- Deu 19:15
- Job 33:14
- 8MR 413.2
- Isaiah 46:
- Isaiah 1:1 (4 kings)
- Exodus 20:5 (4 generations)
- Joel 1:3 (4 generations)
- Joel 1:4 (4 insects)
- Dan. 9:24-26
- Gal 4:25, 26
- Isa 6:13
- Matthew 24:15, 16
- Joel 1:2
- 2 Kings 18:9-12
- Amos 1:1
- Hos 1:1

Selected Messages volume three page 339 paraphrasing:

The Bible has collected and bound together treasures for the last generation. All the great events and solemn transactions of the Old Testament history have been and are repeating themselves in the church in these last days. All the experiences of God's people in the Old Testament are repeating today. Concentrating all the influence of the past with new and increased light of the present. Accrued power, power that's collected is given to everyone who will follow this light. God wants us to do the following, as an example, take all of this history these 39 verses of Daniel 11 and concentrate them into the present experience that we're having. And all of this light, which is all collected together will be given to us if we follow the light. That's why I think it's important to understand how parable teaching works at a prophetic level. The church are experts at understanding parables at the moral level.

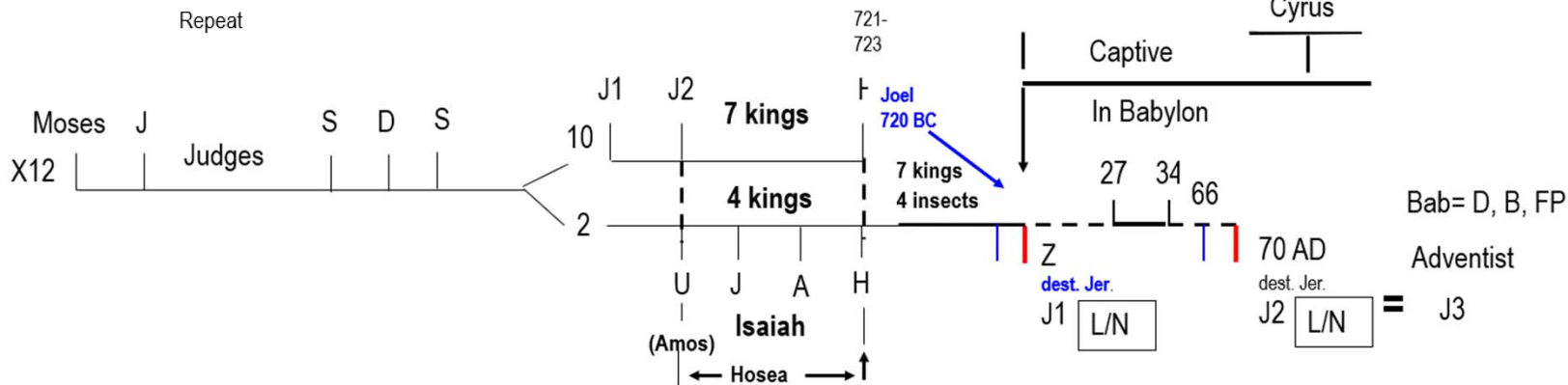
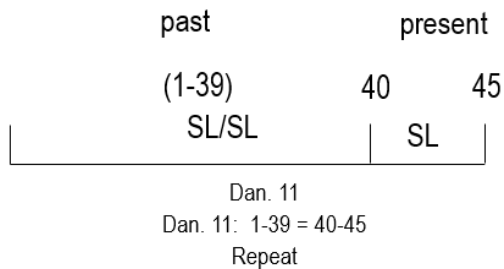

- 9T 11.1 321 1st SL
- 9T 14.2 538 2nd SL
- 13MR 394.1
- Deu 19:15
- Job 33:14
- 8MR 413.2
- Isaiah 46:
- Isaiah 1:1 (4 kings)
- Exodus 20:5 (4 generations)
- Joel 1:3 (4 generations)
- Joel 1:4 (4 insects)
- Dan. 9:24-26
- Gal 4:25, 26
- Isa 6:13
- Matthew 24:15, 16
- Joel 1:2
- 2 Kings 18:9-12
- Amos 1:1
- Hos 1:1

Selected Messages volume three-page 419 paragraph 5

Men of the Old Testament they spoke about things that happened in their day, but they didn't only speak about the things that concerned them. Their vision, their sight reached down to the future on what should occur these last days. She mentions Daniel, Isaiah, Ezekiel. Isaiah, she says his vision reached all the way to the end of the world as did Ezekiel's and Daniel's. But I'm arguing Isaiah speaks about his own present time. And when he speaks about us it's not chapter one for him and chapter 2 for us, or the first five chapters for his history in the second five chapters for us, it doesn't work that way. Every single chapter in the book of Isaiah is for his generation. So how does it have a fulfillment in our generation? The events that he speaks about have to happen again, it's I think self-evident. Not only is Ellen White saying it, but common sense would teach us. I know you've all read the book of Isaiah, there is not a single verse that talks specifically about the end of the world separate and distinct from his present history. The book isn't structured that way, it's structured on this concept on repeating histories.

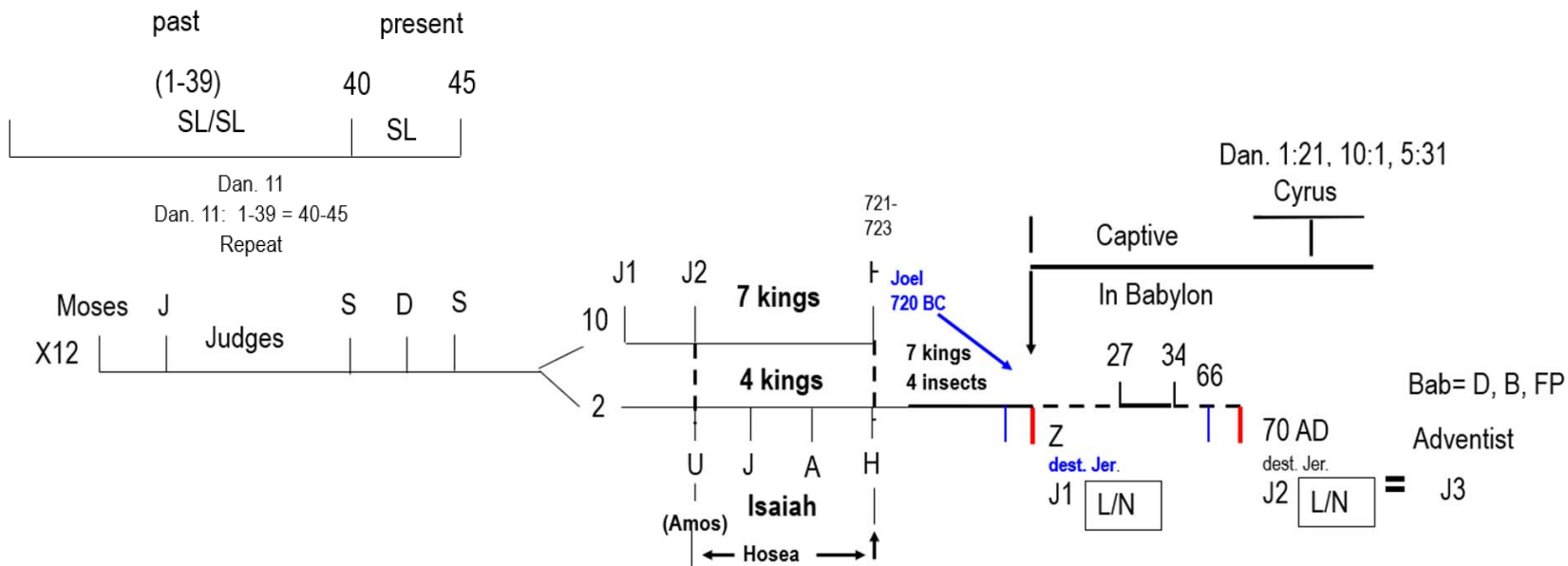

Second Selected Messages page 109 paragraph 2:

Those things which have been will be repeated, old controversies will be renewed. And new theories will continually be arising.

Testimonies to Ministers page 116:

Study Revelation and Daniel because history will repeat. The histories of the Old Testament are being repeated in the New Testament, particularly in the books of Daniel and the Revelation. I'll give you an example, Revelation 13 is the Sunday law history. Go to verse 13. There's a beast verse 11, that comes up out of the Earth with two horns it looks like a lamb but speaks as a dragon. In verse 13 this beast will bring fire down from heaven. Now if you know your Old Testament history well, then you will know that this is a story from the Old Testament. Is there a story where people are bringing fire down from heaven? Yes, there is in 1 Kings chapter 8 the story of Elijah on Mount Carmel. Two prophets: the true prophet and the false prophet.

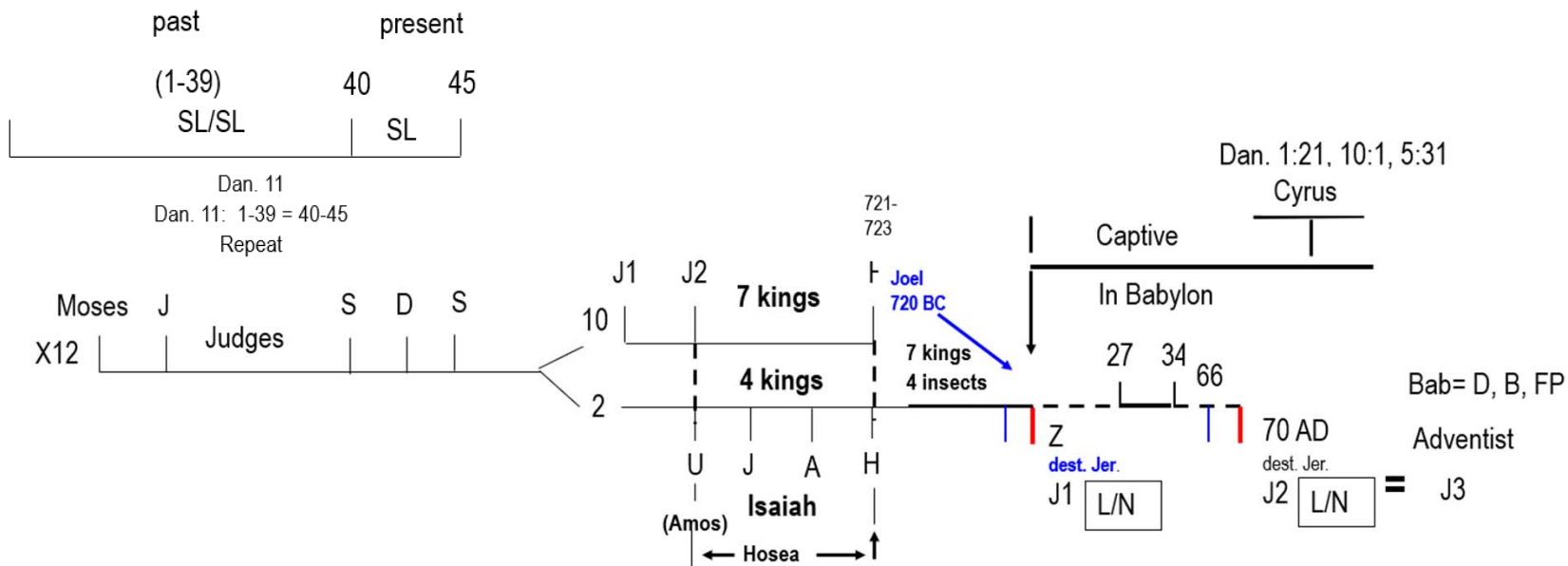

- 9T 11.1 321 1st SL
- 9T 14.2 538 2nd SL
- 13MR 394.1
- Deu 19:15
- Job 33:14
- 8MR 413.2
- Isaiah 46:
- Isaiah 1:1 (4 kings)
- Exodus 20:5 (4 generations)
- Joel 1:3 (4 generations)
- Joel 1:4 (4 insects)
- Dan. 9:24-26
- Gal 4:25, 26
- Isa 6:13
- Matthew 24:15, 16
- Joel 1:2
- 2 Kings 18:9-12
- Amos 1:1
- Hos 1:1

And the test is who is the true God, who brings fire down from heaven in the Old Testament story? The true or the false prophet? The true prophet. What happens to the false prophets? They are killed, this is Mount Carmel. Do we know what is at the base of Mount Carmel? It's the valley of Megiddo where the word Armagiddo or Armageddon comes from. So the story of Armageddon is the story of Mount Carmel. But in the original story the true prophet wins. In this story it's this beast that's going to bring fire down from heaven. We read Revelation 16, Babylon is formed in how many parts, three parts, the dragon, the beast, and the false prophet. The false prophet is the person that brings fire down from heaven because it's the story of Elijah. So you know that in Revelation 13 this beast that looks like a lamb and speaks as a dragon is a false prophet because it's taken directly from the story of Mount Carmel. If you're not familiar with Old Testament stories you won't see how history is going to repeat. At the end of the world the true God or the false God is going to bring fire down from heaven, which one? It's the false god.

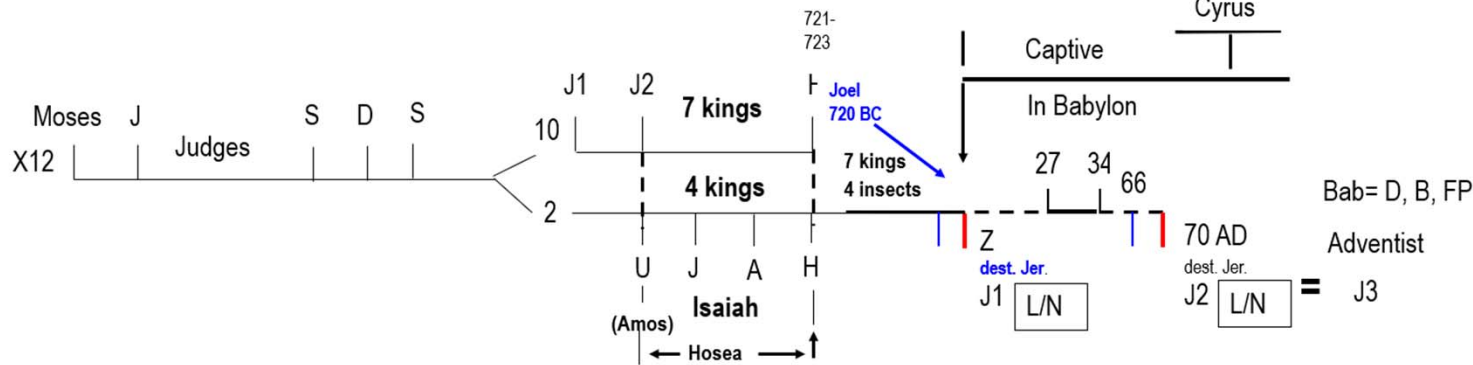
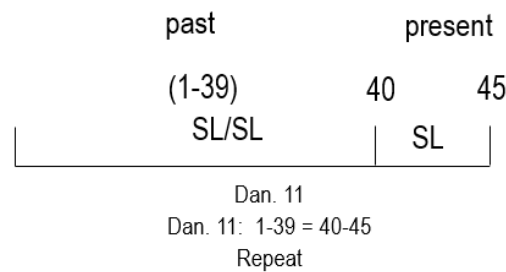
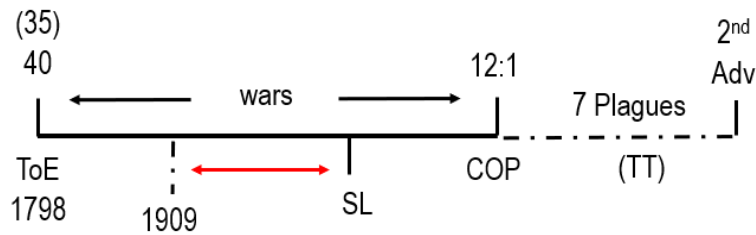

- 9T 11.1 321 1st SL
- 9T 14.2 538 2nd SL
- 13MR 394.1
- Deu 19:15
- Job 33:14
- 8MR 413.2
- Isaiah 46:
- Isaiah 1:1 (4 kings)
- Exodus 20:5 (4 generations)
- Joel 1:3 (4 generations)
- Joel 1:4 (4 insects)
- Dan. 9:24-26
- Gal 4:25, 26
- Isa 6:13
- Matthew 24:15, 16
- Joel 1:2
- 2 Kings 18:9-12
- Amos 1:1
- Hos 1:1

What will happen to the true prophets? If in the Old Testament the false prophets were killed who's going to be killed in the new in the present? So we can see that the Bible is teaching in the Sunday law history there's going to be bloodshed amongst God's people when the false god and his false prophets deceive the world and turn against God's Messengers. This is my understanding of how parables work at a prophetic level, how we're supposed to take Old Testament stories and bring them into the present. Our church teaches that when the Sunday law comes it'll be time to prepare. But that stands in opposition to Old Testament models, to nature, and we'll discuss that as we continue our studies because it's not just about the past repeating in the present. The Bible talks about other models, the model of marriage, the model of agriculture, the model of construction, and the model of geography. When you understand geography, it will help you to understand end time prophecy.

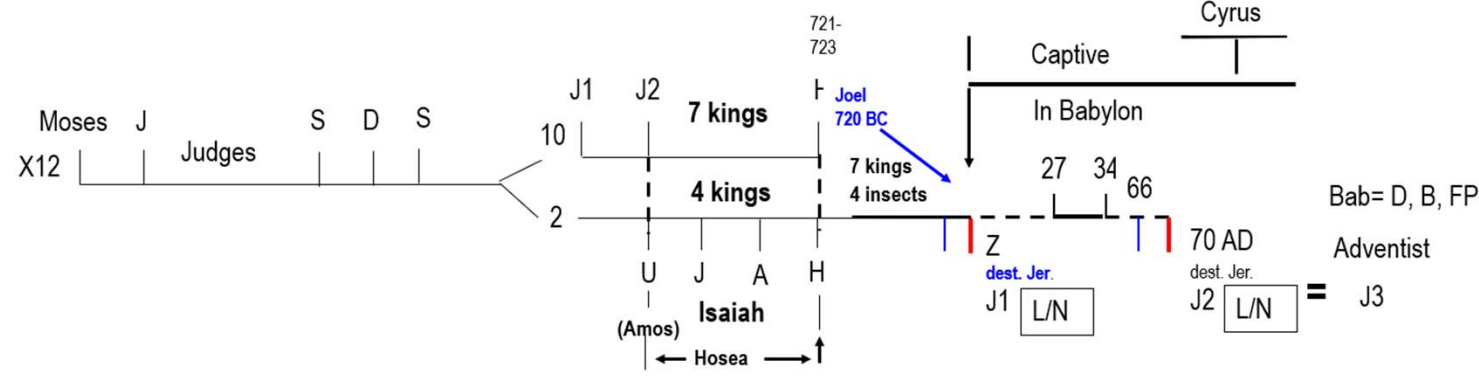
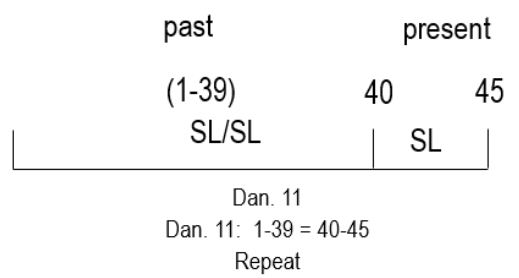
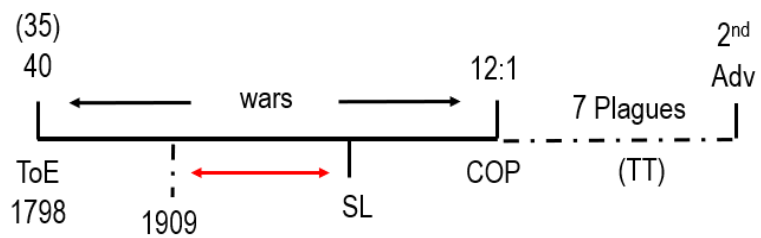

- 9T 11.1 321 1st SL
- 9T 14.2 538 2nd SL
- 13MR 394.1
- Deu 19:15
- Job 33:14
- 8MR 413.2
- Isaiah 46:
- Isaiah 1:1 (4 kings)
- Exodus 20:5 (4 generations)
- Joel 1:3 (4 generations)
- Joel 1:4 (4 insects)
- Dan. 9:24-26
- Gal 4:25, 26
- Isa 6:13
- Matthew 24:15, 16
- Joel 1:2
- 2 Kings 18:9-12
- Amos 1:1
- Hos 1:1

In the time period when our church says we need to prepare is the time period where there will be bloodshed. Because today is the day of preparation. I'll give you some examples of how history repeats. Testimonies to the Church volume five page 160, Ancient Israel, talking about the children of Israel when they were entering into the land of Canaan. We spoke about this, Egypt, wandering in the wilderness, going into the Promised Land. Ellen White says we are repeating that history; we've come out of the world, we're wandering in the wilderness because of our rebellion and apostasy and we're waiting to go into the heavenly Canaan not the earthly.

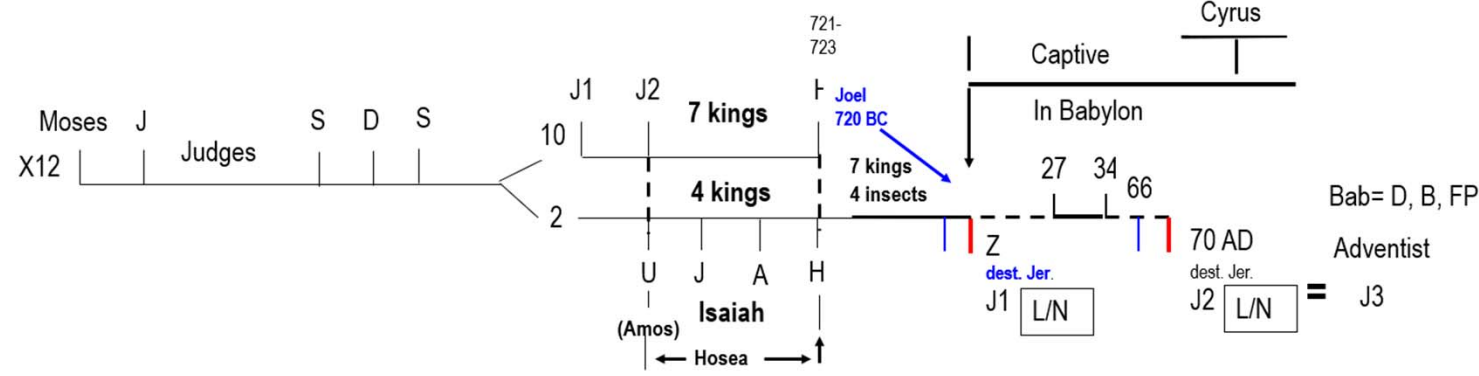
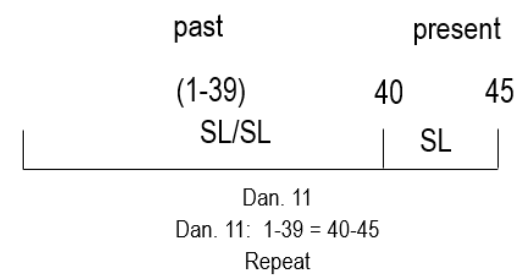
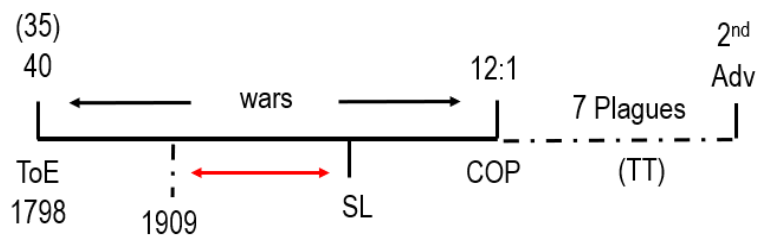

- 9T 11.1 321 1st SL
- 9T 14.2 538 2nd SL
- 13MR 394.1
- Deu 19:15
- Job 33:14
- 8MR 413.2
- Isaiah 46:
- Isaiah 1:1 (4 kings)
- Exodus 20:5 (4 generations)
- Joel 1:3 (4 generations)
- Joel 1:4 (4 insects)
- Dan. 9:24-26
- Gal 4:25, 26
- Isa 6:13
- Matthew 24:15, 16
- Joel 1:2
- 2 Kings 18:9-12
- Amos 1:1
- Hos 1:1

We'll see how Joe repeats, Desire of Ages page 471. This is talking about job's friends. The same error for which God told off Job's friend was repeated by the Jews when they rejected Christ. So if you go to the story of Job, the friends rejecting Job is the repeating story of God's people rejecting Jesus. And in Early Writings Ellen White compares that to God's people rejecting The Three Angels Messages, history repeats.

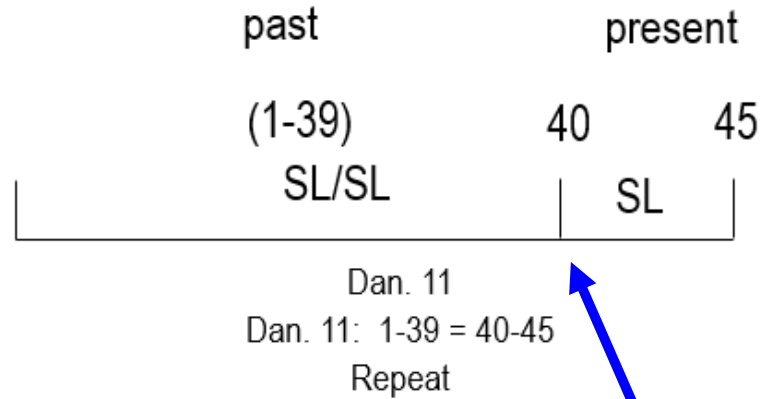
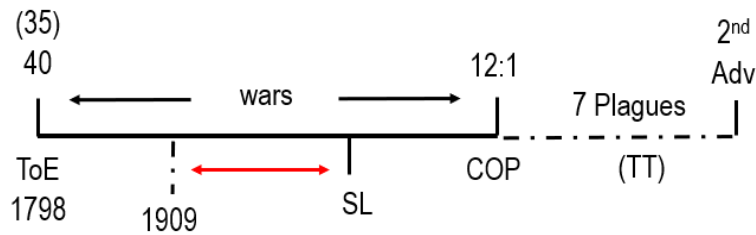

- 9T 11.1 321 1st SL
- 9T 14.2 538 2nd SL
- 13MR 394.1
- Deu 19:15
- Job 33:14
- 8MR 413.2
- Isaiah 46:
- Isaiah 1:1 (4 kings)
- Exodus 20:5 (4 generations)
- Joel 1:3 (4 generations)
- Joel 1:4 (4 insects)
- Dan. 9:24-26
- Gal 4:25, 26
- Isa 6:13
- Matthew 24:15, 16
- Joel 1:2
- 2 Kings 18:9-12
- Amos 1:1
- Hos 1:1

Nebuchadnezzar: Signs of the Times May 6th 1897. History will be repeated, false religion will be exalted. The first day of the week will be set up as was the image of Babylon. Nebuchadnezzar was the leader of a kingdom, which was a beast, Nebuchadnezzar was the beast. He created an image which is Daniel chapter 3, an images of the beast. It's a clear story of a Sunday law experience, clear biblical story of that experience that we are about to enter into. Our church doesn't fully understand what the image of the beast is. If you went to the story of Daniel chapter 3 it would help us to understand and clarify what the issue is. I'll add one point, the image of he beast had to be built before you worship it. [The worshipping of the image of the beast is here](#), we have to ask ourselves why is there an image, why don't they worship beast? Because God has encoded in those stories a prophetic message. Today, that image is already being established and set up. Most Adventists are not aware of it so they're going to get caught by surprise when the Sunday law comes and they're commanded to worship.

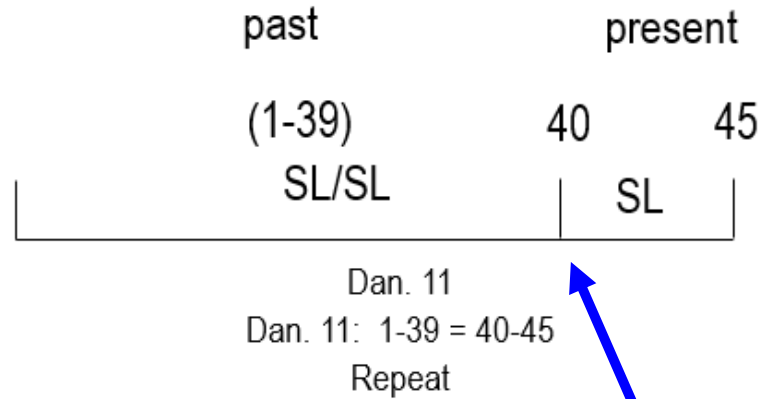
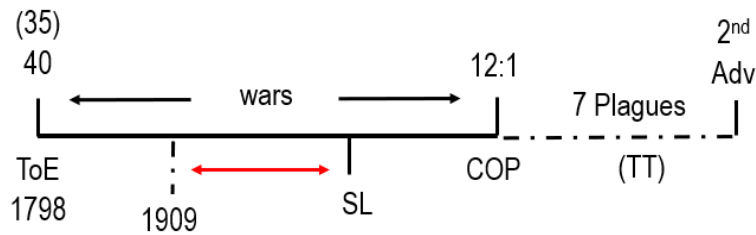

- 9T 11.1 321 1st SL
- 9T 14.2 538 2nd SL
- 13MR 394.1
- Deu 19:15
- Job 33:14
- 8MR 413.2
- Isaiah 46:
- Isaiah 1:1 (4 kings)
- Exodus 20:5 (4 generations)
- Joel 1:3 (4 generations)
- Joel 1:4 (4 insects)
- Dan. 9:24-26
- Gal 4:25, 26
- Isa 6:13
- Matthew 24:15, 16
- Joel 1:2
- 2 Kings 18:9-12
- Amos 1:1
- Hos 1:1

Nehemiah: Signs of the Times December 13th, 1883. The experience of Nehemiah is repeated in the history of God's people in this time. What does Nehemiah have to do? He has to rebuild the wall and the gates. What is the wall? It's the thing that separates God's people from the world, the wall is the Sabbath. At that time the Sabbath in 1883, just before 1888, because there's a buildup by the National Reform Movement in the United States, we read about it earlier, when they connected the reform movement to themselves, there was a destabilizing and a disparaging of the Sabbath. To try to direct people away from the Sabbath to Sunday. Nehemiah was commanded to go to God's people and encourage them to remain firm and build the Sabbath.

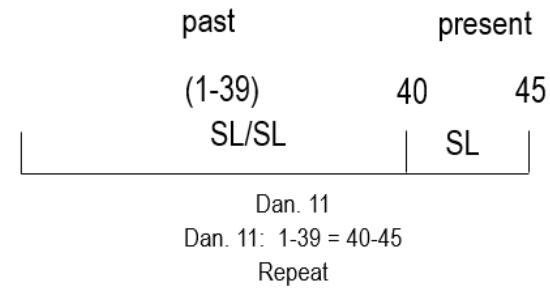
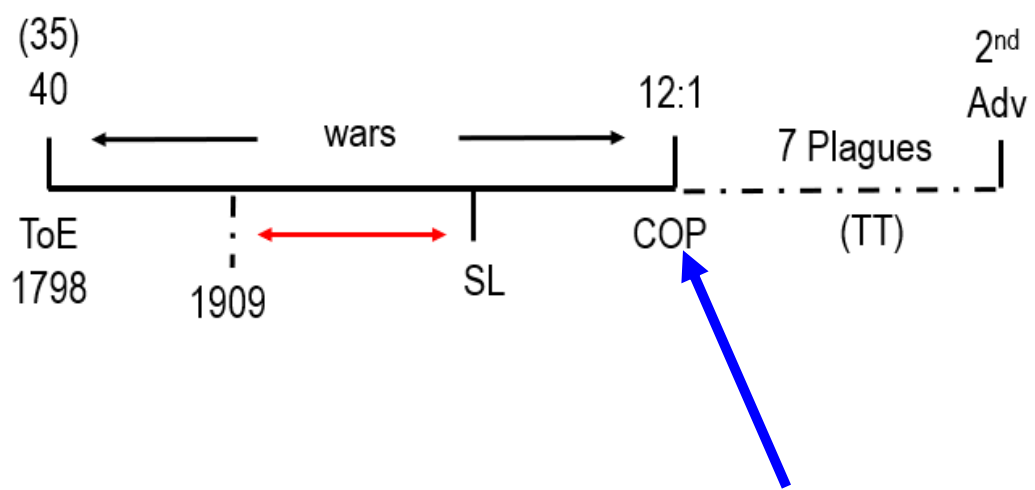

- 9T 11.1 321 1st SL
- 9T 14.2 538 2nd SL
- 13MR 394.1
- Deu 19:15
- Job 33:14
- 8MR 413.2
- Isaiah 46:
- Isaiah 1:1 (4 kings)
- Exodus 20:5 (4 generations)
- Joel 1:3 (4 generations)
- Joel 1:4 (4 insects)
- Dan. 9:24-26
- Gal 4:25, 26
- Isa 6:13
- Matthew 24:15, 16
- Joel 1:2
- 2 Kings 18:9-12
- Amos 1:1
- Hos 1:1

Esther, [we marked here](#), the death decree just after Michael stands up. This is taken from the Signs of the Times November 8th, 1899. The decree which is to go forth against God's people in the near future, that's this one the death decree that she's referring to, is in some respect similar to that issue by Ahasuerus against the Jews in the time of Esther. She then goes on to say history repeats itself. That same masterful mind of Satan is working today as he worked in the past.

Talking about the story of Elijah she's going to quote 1st Corinthians chapter 10 verse 11. *For us upon whom the ends of the world have come, the story of Elijah has special significance because history is repeating.* And I explained that already. Taken from Prophets and Kings page 177.

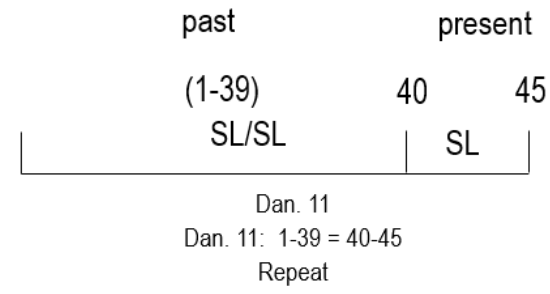
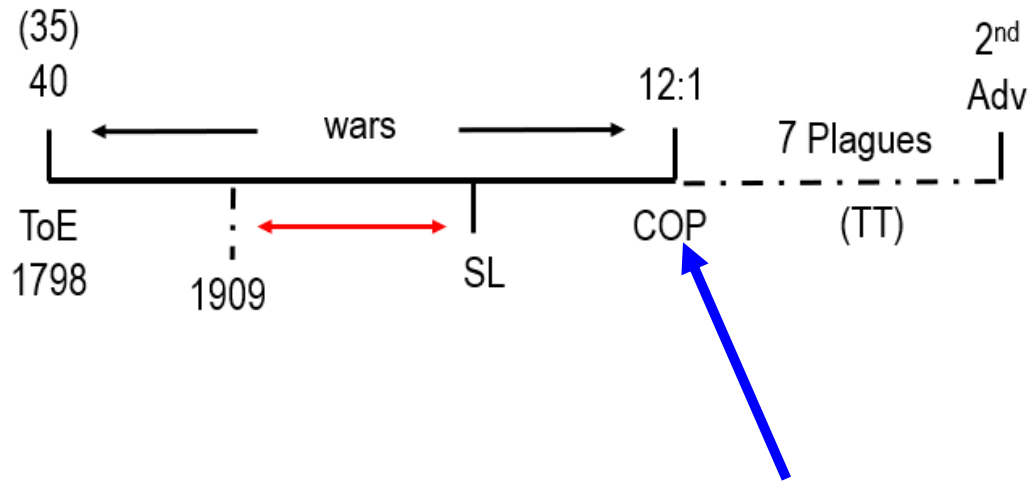

- 9T 11.1 321 1st SL
- 9T 14.2 538 2nd SL
- 13MR 394.1
- Deu 19:15
- Job 33:14
- 8MR 413.2
- Isaiah 46:
- Isaiah 1:1 (4 kings)
- Exodus 20:5 (4 generations)
- Joel 1:3 (4 generations)
- Joel 1:4 (4 insects)
- Dan. 9:24-26
- Gal 4:25, 26
- Isa 6:13
- Matthew 24:15, 16
- Joel 1:2
- 2 Kings 18:9-12
- Amos 1:1
- Hos 1:1

Next one is Review and Herold April the 20th 1897. *The Old and the New Testaments are linked together. We need to become familiar with the Old Testament scriptures. The unchangeableness of God should be clearly seen. The similarity of his dealings with his people in the past and the present should be studied.* This is why I make an emphasis on the past and the present, what I'm about to read: *In Mercy to us God repeats his past dealings. He's given us a record of his dealings in the past, this we need to study carefully because history is repeating itself.* And we are more accountable than those people were in the Old Testament because we have the ability to learn from their mistakes. To put it simply, the reason why Adventism is not familiar with using parables to understand prophecy is because we are in the Laodicean condition. And that is not just an excuse, if we have time, I want to lay out what the prophetic understanding of what the Laodicean condition actually is. I'll give you the dates and Satan's methodology of how the Laodicean condition came upon God's people, it's clearly laid out in inspiration.

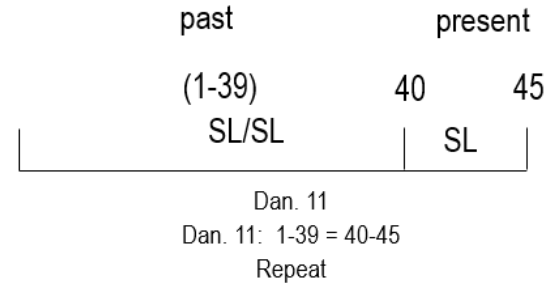
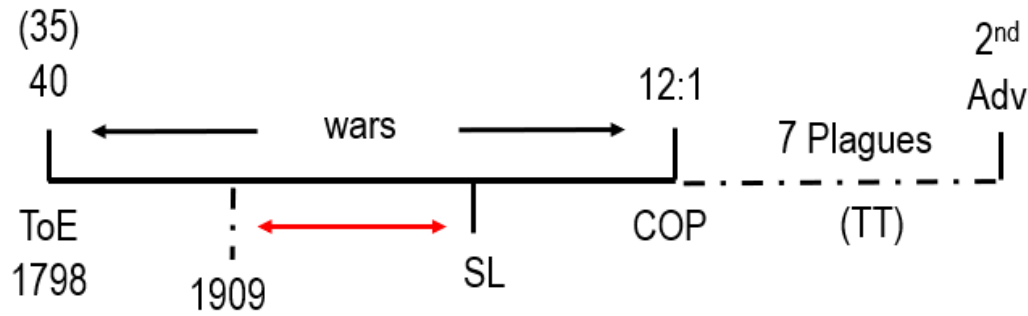

9T 11.1 321 1st SL
 9T 14.2 538 2nd SL
 13MR 394.1
 Deu 19:15
 Job 33:14
 8MR 413.2
 Isaiah 46:
 Isaiah 1:1 (4 kings)
 Exodus 20:5 (4 generations)
 Joel 1:3 (4 generations)
 Joel 1:4 (4 insects)
 Dan. 9:24-26
 Gal 4:25, 26
 Isa 6:13
 Matthew 24:15, 16
 Joel 1:2
 2 Kings 18:9-12
 Amos 1:1
 Hos 1:1

There are many more pages about history repeating, this is just a small sample of it. The reason why Adventism is not more are not more familiar with these things is because we've separated the prophetic understanding of inspiration from the moral understanding. When you bring them together not only will you have a clear understanding of what's about to happen, as Ellen White says, *if the books of Daniel and Revelation were better understood we will have it all together different religious experience, which means our morality will change. And that's why God's people are in such a condition today. Once you do what God had done, bring two things together and as the Bible says not to separate them, prophecy and morality will join like a husband and wife and become one flesh. Things that seem obscure will suddenly become clear.*

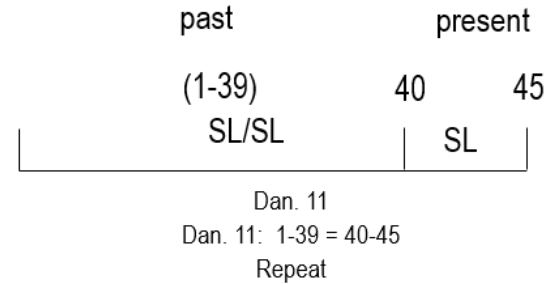
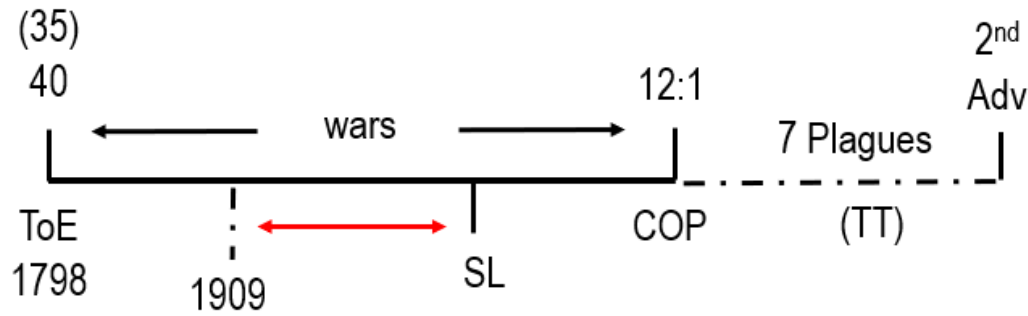

9T 11.1 321 1st SL
 9T 14.2 538 2nd SL
 13MR 394.1
 Deu 19:15
 Job 33:14
 8MR 413.2
 Isaiah 46:
 Isaiah 1:1 (4 kings)
 Exodus 20:5 (4 generations)
 Joel 1:3 (4 generations)
 Joel 1:4 (4 insects)
 Dan. 9:24-26
 Gal 4:25, 26
 Isa 6:13
 Matthew 24:15, 16
 Joel 1:2
 2 Kings 18:9-12
 Amos 1:1
 Hos 1:1

Let's pray

Dear Lord, I want to give you praise and thanks that you showed me how history repeats, and in my personal experience, how you've encouraged me step by step, showing me what kind of a person I need to be. You can do that for each of us bowed before you if we are willing to see you speaking to us through these stories. Not just in a moral sense which we all agree on but in a prophetic sense. We pray in Jesus' name amen.

9T 11.1 321 1st SL
 9T 14.2 538 2nd SL
 13MR 394.1
 Deu 19:15
 Job 33:14
 8MR 413.2
 Isaiah 46:
 Isaiah 1:1 (4 kings)
 Exodus 20:5 (4 generations)
 Joel 1:3 (4 generations)
 Joel 1:4 (4 insects)
 Dan. 9:24-26
 Gal 4:25, 26
 Isa 6:13
 Matthew 24:15

SL1 + SL2 = SL3

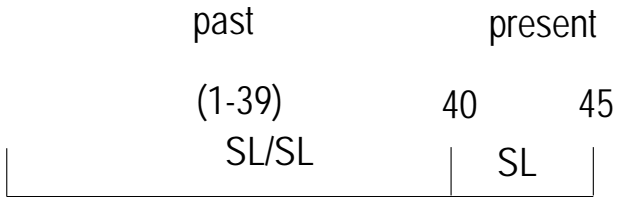

Dan. 11
 Dan. 11: 1-39 = 40-45
 Repeat

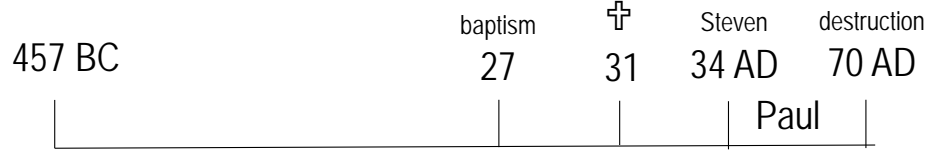

70 weeks - 490 years

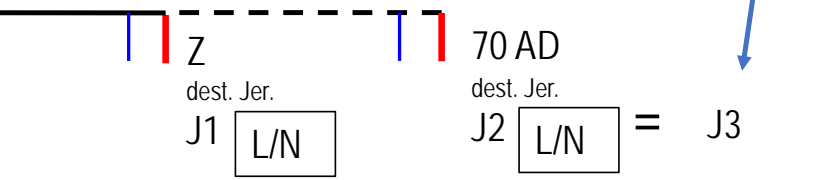

Heavenly Father, we thank You Lord that in Your mercy You have warned us of what's to come. You have shown us over and over again what things will be like at the end of the world. But we, Your children, have not heard Your voice, we've lost our direction. It's my prayer that these studies would be a blessing to those that hear them. May it be Your voice speaking, showing the remnant how to prepare.

In Jesus' name
 Amen

